

## 2/2 DIRECT ACTING, NC/ NO ( ALL PORTS IN BODY) SOLENOID VALVE

TYPE	PRESSURE

TYPE	PRESSURE
20270	0 - 20 bar

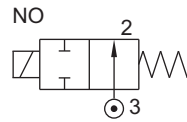

TYPE	PRESSURE



### FEATURES

- Bubble tight shut off
- Manual override optionally provided
- Suitable for vacuum up to 10<sup>-6</sup> torr
- Vibration resistance up to 9g
- Suitable for high speed cycling
- Speed up to 1000 cycles/ min.
- Life >10 million cycles



### WETTED PARTS

Code		B2	B5
Body		Brass	SS 316
Internals		Brass and Plastic	SS 316 and Plastic
Guide Assembly	SS 304		
Shadow-Ring	Copper/ Silver/ None		
Plunger, Insert	SS 430		
Spring	SS 302		
Seat, Seals	NBR, Viton, EPDM		

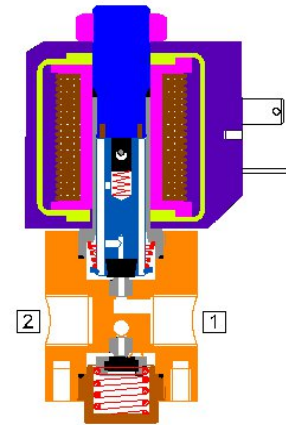

### AMBIENT AND FLUID TEMPERATURE

-30 °C to 75 °C

### SPECIAL VERSION AND SUFFIX

Suffix : (Valve) OX, AM  
Special version : (Solenoid) CO, FR, SS, LC, III, TM

### MEDIA

Air, Inert gases, Water, Free flowing liquid, Oil, Diesel, Kerosene, LPG

### APPLICATION

Analyzer and Dispensing

### PORT CONNECTION

ACTION	INLET	OUTLET
NC	1	2
NO	3	2

Contact Rotex for

- Any other ambient, fluid temperature, media and application
- UL listed, Listed general purpose Valve



### SPARES

(Refer page 25 for ordering code)

SPARE KIT	CODE
Seal Kit : Oring Set and Plunger Assembly	98
Repair Kit : Oring Set, Plunger Assembly, Springs, Manual Override, Guide assembly	99
Solenoid Kit : Solenoid, Gasket and Nut	34

### APPROVAL

(\* applied for)

Approval	Nema 4X	IP67	Ex d IIC T4 or T5 or T6 IP66	Ex ia IIC T6 IP67	DGMS	CCOE
		✓	✓	✓	✓	✓
CE		✓	✓	✓		
UL	✓		*			
			✓	✓		
EAC			✓	✓		
			✓	✓		





# DIN PLUG IN SOLENOID TYPE : 22, 25

## CIRCUIT DIAGRAM

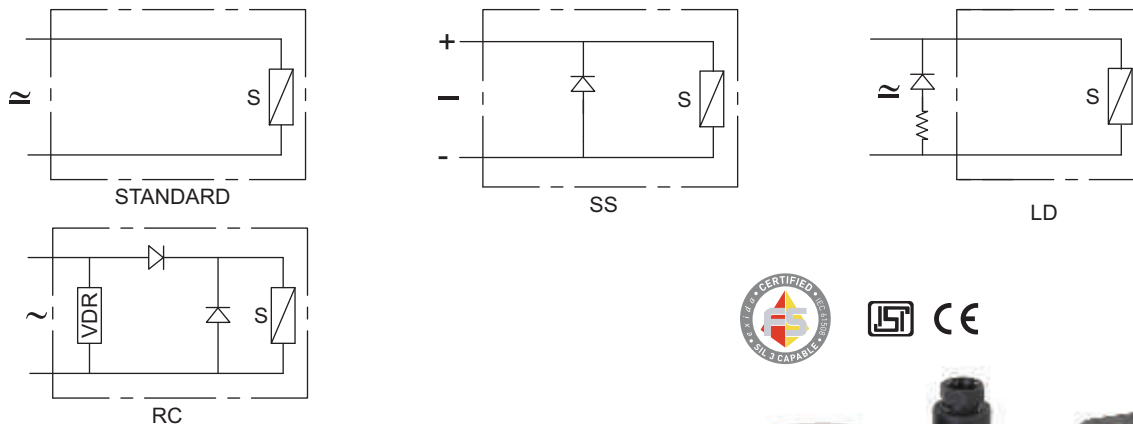

## FEATURES

- Designed for extreme environmental condition
- Constructed for lowest temperature rise thus longer life
- 'O' Energiser for higher magnetic linkage
- Wider voltage variation
- DIN Plug supplied with Solenoid

## SPECIFICATION

<b>Size</b>	I-14 mm, II-18 mm & III-14 mm, 13mm, IV-14mm
<b>Voltage</b>	6 V, 12 V, 24 V, 48 V, 110 V, 220 V
<b>Current</b>	50 Hz, 60 Hz, DC
<b>Enclosure</b>	<b>Cable Entry</b> Pg 9 : As per DIN 43650 Type A & Type B <b>Material</b> Moulded plastic, Steel Chrome plated
<b>Options</b>	Surge Suppressor (SS), LED (LD), Low Power (LW), Rectified (RC)
<b>Power</b>	Refer to table "Power" on page 425A
<b>Insulation Class</b>	Class F, Optionally Class H
<b>Weather Protection</b>	IP67, IP67 M
<b>Approval</b>	Indian, European, SIL
<b>Voltage Variation</b>	Refer to Voltage Variation Table (on page 425B)
<b>Duty Cycle</b>	100% (ED)
<b>Ambient Temperature</b>	Class F, Power ≤ 13W, -20 °C to 75 °C Class H, Power ≤ 13W, -20 °C to 100 °C, Power ≥ 13W, -20 °C to 75 °C

## WEIGHT IN kg

Size	Moulded Plastic	Steel
I	0.2	0.250
II		0.450
III		0.370

## APPLICATION



INDOOR



OUTDOOR

## DIN PLUG IN SOLENOID TYPE : 22, 25

### POWER

Voltage	Solenoid		Power (VA)						
	Size	Core Dia	0.4 <sup>②</sup>	1.8 <sup>②</sup>	3.5	8	12	13	30 <sup>②</sup>
6	I	14							
	II	18				✓		▲	
	III	13	✓						
	III	14		✓	✓	▲			
	IV	14		✓					
12	I	14				▲	▲		
	II	18				✓		▲	✓
	III	13	✓						
	III	14		✓	✓	▲			
	IV	14		✓					
24	I	14		✓		▲	▲		
	II	18				✓		▲	✓
	III	13	✓						
	III	14		✓	✓	▲			
	IV	14		✓					
48	I	14				▲	▲		
	II	18						▲	✓
	III	14		✓	✓	▲			
110-120	I <sup>①</sup>	14					▲		
	II	18				✓		▲	✓
	III	14				▲			
220-240	I <sup>①</sup>	14					▲		
	II	18				✓		▲	✓
	III	14				▲			
256 <sup>②</sup>	II	18				✓		▲	✓
	III	14				▲			

▲ Standard

✓ Optional Available

① Select Current 50 Hz or 60 Hz

② Select Current DC

### STANDARD POWER

Size	Current	Standard Power W, VA
I	AC	6, 12
	DC	8, 8
II	AC	13, 13
	DC	13, 13
III	AC	6, 12
	DC	8, 8

# DIN PLUG IN SOLENOID TYPE : 22, 25

## SOLENOID ORDERING CODE III-24V-DC-22-SS-LD-LW5-H

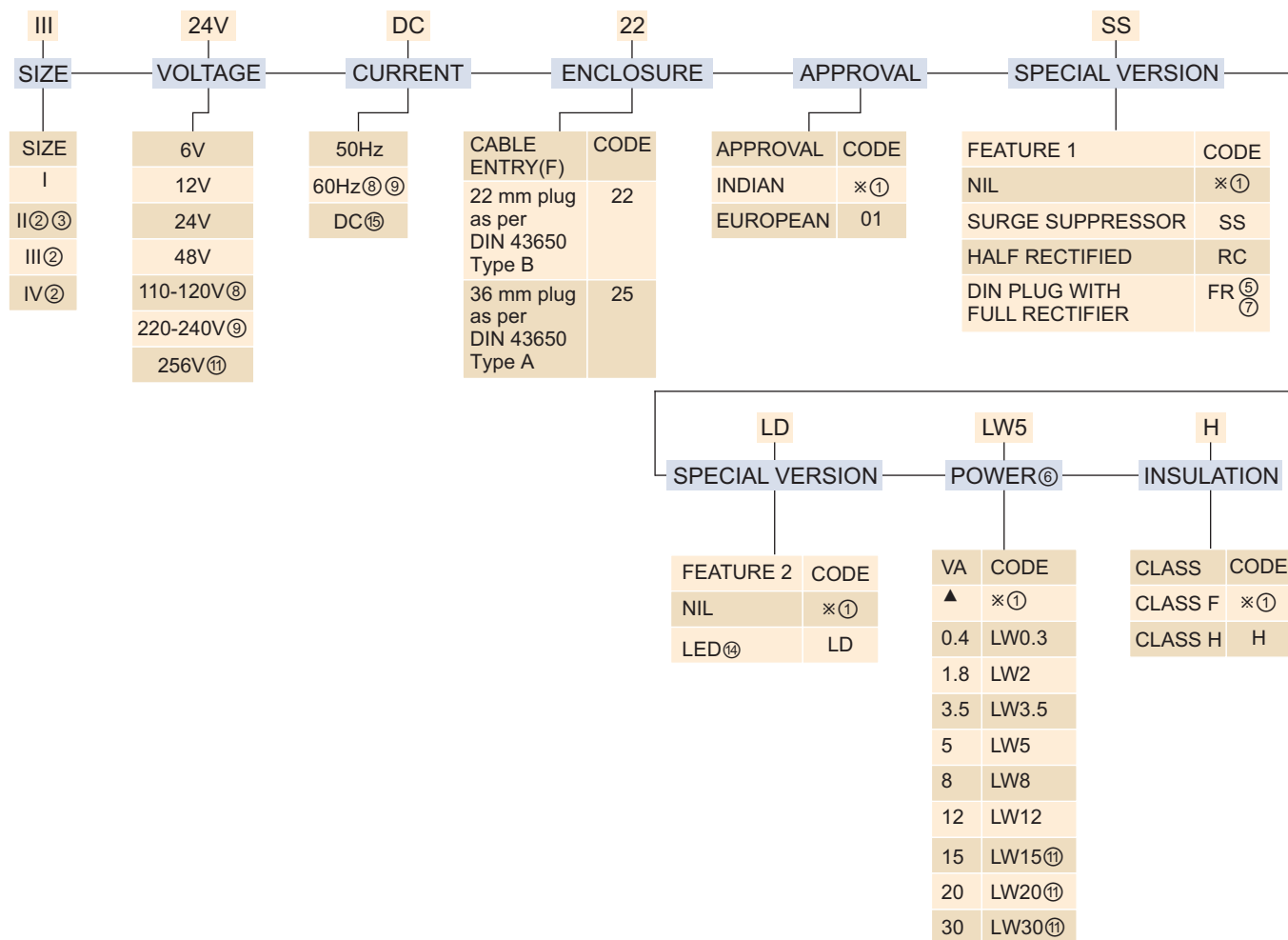

- NOTE :
- ① Do not specify
  - ② Select enclosure code 25
  - ③ Current 50 Hz, 60 Hz, Select Special version RC
  - ④ Select DC current coil to operate for 50 Hz or 60 Hz e.g. 110V DC-25-PR can be use for 110V 50 Hz or 120V, 60 Hz or DC
  - ⑤ Refer Power table on page 425A
  - ⑥ FR option will be available with coil type 25 only
  - ⑧ 110-120V 50 Hz Solenoid can be used for 110V 50 Hz, 120V 60 Hz
  - ⑨ 220-240V 50 Hz Solenoid can be used for 220-240V 50 Hz, 240V 60 Hz
  - ⑩ Select Special version PR for current 50 Hz or 60 Hz
  - ⑪ Voltage 24, 110, 220V current 50 Hz, 60 Hz, DC, LED provided in DIN plug
  - ⑫ 110-120V, 220-240V, current DC, size II, III

### VOLTAGE VARIATION (For Continuous Duty only)

Rated Voltage	Operating Voltage
6	4.8V to 7.2V
12	9.6V to 14.4V
24	19.2V to 28.8V
48	38.4V to 57.6V
110-120	88V to 132V
220-240	176V to 264V
256	192V to 280V

**DIN PLUG IN SOLENOID TYPE : 22, 25**

**DIMENSION SOLENOID TYPE : 22**

Plug as per DIN 43650 Type B

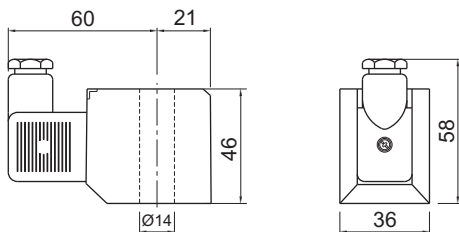

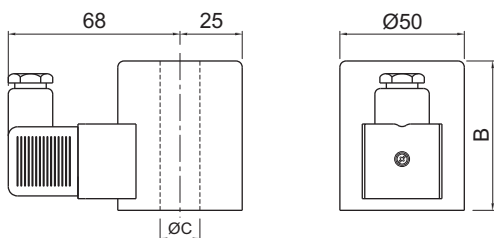

**SOLENOID TYPE : 25**

Plug as per DIN 43650 Type A



SIZE	ØC	B
III	13	43
II	18	60
IV	14	60
III	14	43

**OBSELETE PRODUCTS AND ITS INTERCHANGEABILITY**

 <p>Replace with Solenoid code 22 or 25 along with Guide &amp; Plunger Assembly</p>	 <p>Replace with Solenoid coil code 22</p>			
--	---	--	--	--

## FLYING LEAD SOLENOID TYPE : 01, 04, 06

### CIRCUIT DIAGRAM

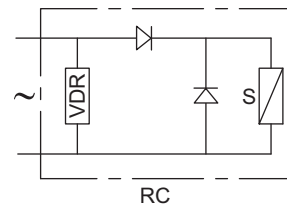
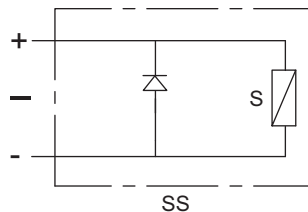
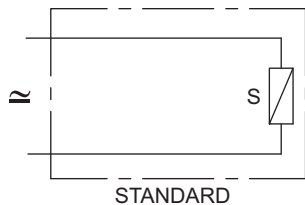

### FEATURES

- Designed for extreme environmental condition
- Constructed for lowest temperature rise thus longer life
- 'O' Energiser for higher magnetic linkage
- Wider voltage variation



### SPECIFICATION

<b>Size</b>	I-14 mm, II-18 mm, III-14 mm
<b>Voltage</b>	6 V, 12 V, 24 V, 48 V, 110 V, 120 V, 220 V
<b>Current</b>	50 Hz, 60 Hz, DC
<b>Enclosure</b>	<b>Cable Entry</b> Flying Leads <b>Material</b> Steel, Chrome Plated
<b>Options</b>	Surge Suppressor(SS)
<b>Power</b>	Refer to table "Power" on page 426A
<b>Insulation Class</b>	Class F optionally Class H
<b>Weather Protection</b>	IP54, Optionally IP67
<b>Approval</b>	Indian
<b>Voltage Variation</b>	Refer to Voltage Variation table (on page 426B)
<b>Duty Cycle</b>	100% (ED)
<b>Ambient Temperature</b>	-20 °C to 60 °C

### WEIGHT IN kg

Size	Steel
I	0.2 kg
II	0.4 kg
III	0.3 kg

### APPLICATION



INDOOR

**FLYING LEAD SOLENOID TYPE : 01, 04, 06**

**POWER**

Voltage	Solenoid		Power (VA)						
	Size	Core Dia					8	12	13
6	I	14					▲		
	II	18							▲
12	I	14					▲	▲	
	II	18							▲
24	I	14					▲	▲	
	II	18							▲
48	I	14					▲	▲	
	II	18							▲
110-120	I①	14						▲	
	II	18							▲
	III	14					▲		
220-240	I①	14						▲	
	II	18							▲
	III	14					▲		

- ▲ Standard
- ✓ Optional Available
- ① Select Current 50 Hz or 60 Hz

**STANDARD POWER**

Size	Current	Standard Power W, VA
I	AC	6, 12
	DC	8, 8
II	AC	13, 13
	DC	13, 13
III	AC	6, 12
	DC	8, 8





**FLYING LEAD SOLENOID TYPE : 01, 04, 06**

**DIMENSION**

**SOLENOID TYPE : 01, 04, 06**

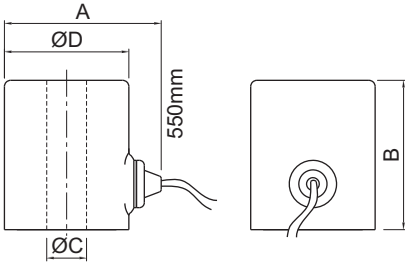

SIZE	A	B	ØC	ØD
I	56	42	14	42
II	64	60	18	50
III	63	43	14	50

**OBSELETE PRODUCTS AND ITS INTERCHANGEABILITY**

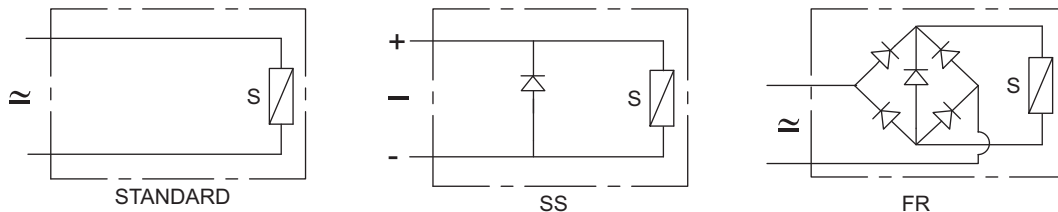

## FLYING LEAD WITH CABLE ENTRY SOLENOID TYPE : 08

### CIRCUIT DIAGRAM

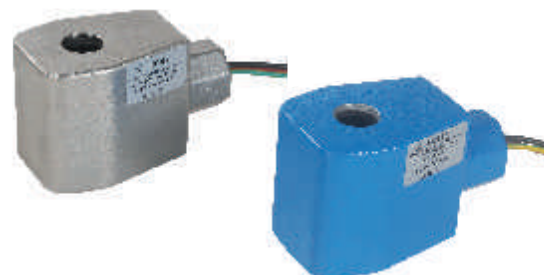

### FEATURES

- Designed for extreme environmental condition
- Constructed for lowest temperature rise thus longer life
- 'O' Energiser for higher magnetic linkage
- Wider voltage variation
- UL Listed file number (applied for)



### SPECIFICATION

<b>Size</b>	II- 18 mm, III- 13 mm, III & IV - 14 mm
<b>Voltage</b>	6 V, 12 V, 24 V, 110 V, 220 V, 256 V, 110-120V, 220-240V
<b>Current</b>	DC, 50/ 60 Hz/ DC
<b>Enclosure</b>	<b>Cable Entry</b> 1/2" NPT (F) <b>Material</b> Aluminum Cast, Polyester Powder coat, Colour Black/ Blue Stainless Steel casting
<b>Options</b>	Surge Suppressor(SS), Fully Rectified (FR), Low Power (LW) Manual Reset ON (MR)
<b>Power</b>	Refer to table "Power" on Page 427A
<b>Insulation Class</b>	Class H
<b>Weather Protection</b>	Type 3, 3S, 3R, 4, 4X, 6, 6P
<b>Approval</b>	UL Listed
<b>Voltage Variation</b>	Refer to Voltage Variation Table (on page 427B)
<b>Duty Cycle</b>	100% (ED)
<b>Ambient Temperature</b>	Power ≤ 20W, -60 °C to 100 °C, Power >20W, ≤30W, -60 °C to 70 °C

### WEIGHT IN kg

Size	Al/ kg	SS/ kg
II	0.7	0.9
III	0.6	

### APPLICATION



INDOOR



OUTDOOR

## FLYING LEAD WITH CABLE ENTRY SOLENOID TYPE : 08

## POWER

Voltage	Solenoid		Power (VA)					
	Size	Core Dia	0.4②	1.8②	3.5	8	13	30
6	II	18				✓	▲	
	III	13	✓					
	III	14		✓	✓	▲		
	IV	14		✓				
12	II	18				✓	▲	✓
	III	13	✓					
	III	14		✓	✓	▲		
	IV	14		✓				
24	II	18				✓	▲	✓
	III	13	✓					
	III	14		✓	✓	▲		
	IV	14		✓				
110-120	II	18				✓	▲	✓
	III	14			✓	▲		
220-240	II	18				✓	▲	✓
	III	14				▲		
256②	II	18				✓	▲	✓
	III	14				▲		

▲ Standard

✓ Optional Available

② Select Current DC

## STANDARD POWER

Size	Current	Standard Power W, VA
I	AC	6, 12
	DC	8, 8
II	AC	13, 13
	DC	13, 13
III	AC	6, 12
	DC	8, 8

# FLYING LEAD WITH CABLE ENTRY SOLENOID TYPE : 08

## SOLENOID ORDERING CODE III-24V-DC-08-H-02

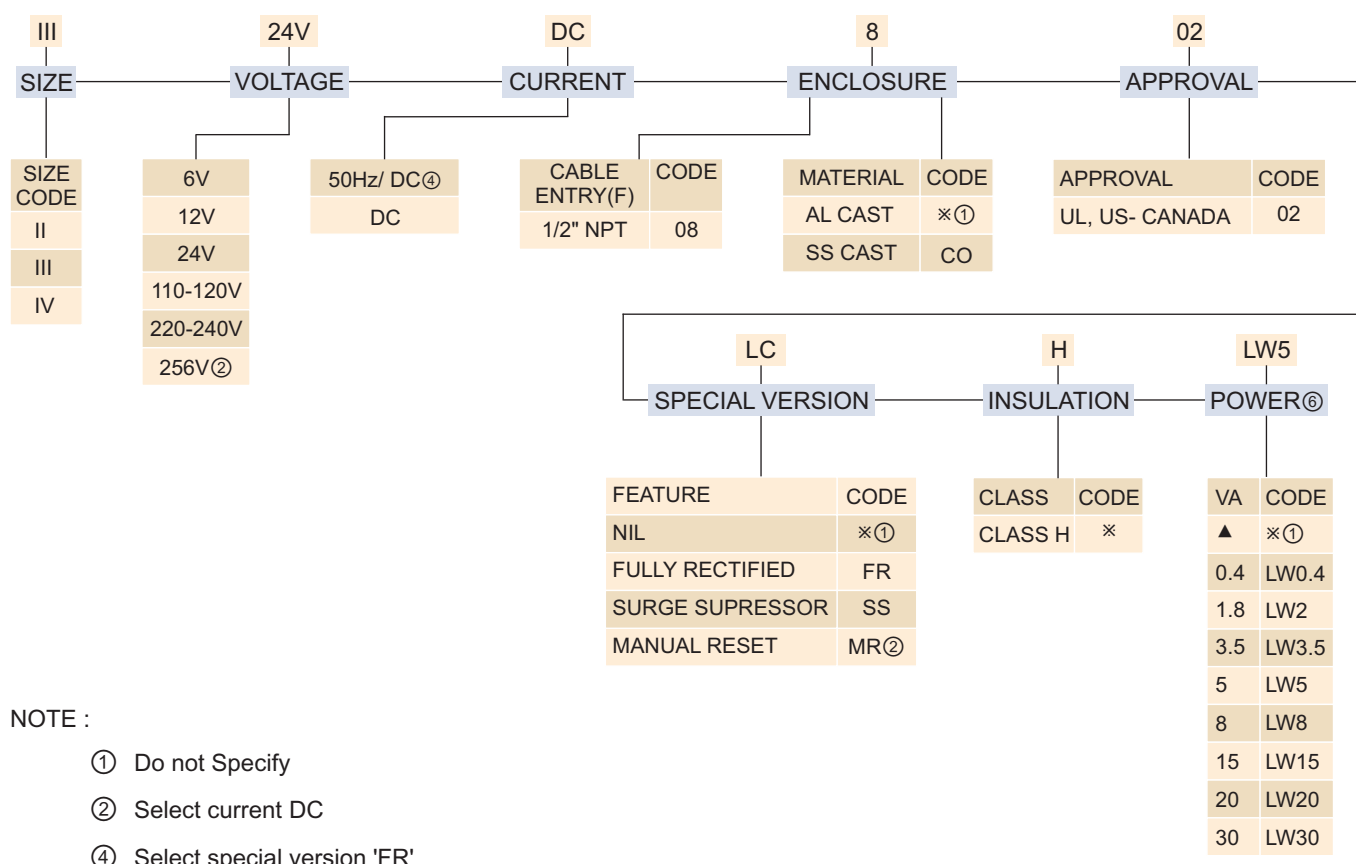

NOTE :

- ① Do not Specify
- ② Select current DC
- ④ Select special version 'FR'
- ⑥ Refer Power table on page 427A

### VOLTAGE VARIATION (For Continuous Duty only)

Rated Voltage	Operating Voltage
6	4.8V to 7.2V
12	9.6V to 14.4V
24	19.2V to 28.8V
48	38.4V to 57.6V
110-120	88V to 132V
220-240	176V to 264V
256	192V to 280V

**FLYING LEAD WITH CABLE ENTRY SOLENOID TYPE : 08**

**DIMENSION**

**SOLENOID TYPE : 08**

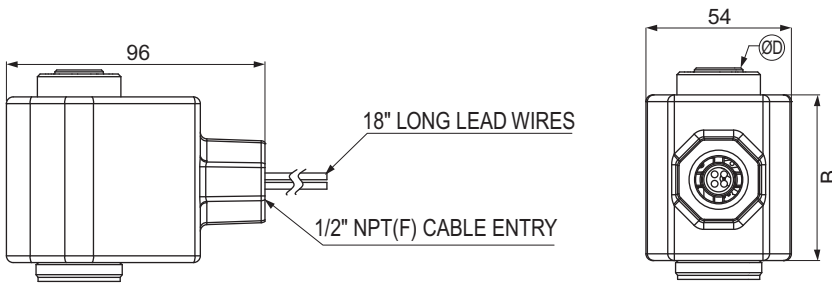

SIZE	B	ØD*
II	61	18
III	47	14
IV	61	14

**OBSELETE PRODUCTS AND ITS INTERCHANGEABILITY**

# TERMINAL BOX SOLENOID TYPE : 16, 19

## CIRCUIT DIAGRAM

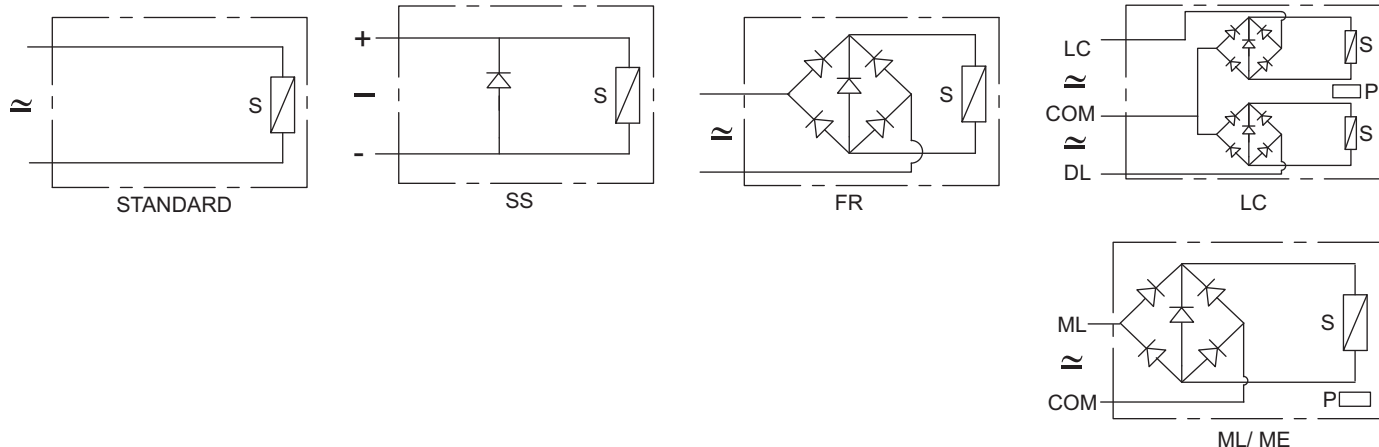

## FEATURES

- Designed for extreme environmental condition
- With Integrated terminal box and Horizontal cable entry
- Wider voltage & frequency variation
- 'O' energiser for higher magnetic linkage
- Large terminals for easy connections
- Internal as well as external earth terminal
- Constructed for lowest temperature rise thus longer life



## SPECIFICATION

<b>Size</b>	I- 14 mm, II- 18 mm, III- 13 mm, III & IV - 14 mm
<b>Voltage</b>	6 V, 12 V, 24 V, 48 V, 110 V, 120 V, 220 V, 256 V
<b>Current</b>	50 Hz, 60 Hz, DC, 50/ 60 Hz/ DC
<b>Enclosure</b>	<b>Cable Entry</b> M25X1.5, Adopted to M20 X 1.5 or 1/2" NPT <b>Material</b> Aluminum Cast Painting : Polyester Powder coated Stainless Steel Cast, Optionally Polyester Powder coated Painted
<b>Options</b>	Surge Suppressor(SS), Fully Rectified (FR), Latch (LC), Latch, Manual Reset OFF (ML), Manual Reset ON (MR), LED (LD)
<b>Power</b>	Refer to table "Power" on Page 428A
<b>Insulation Class</b>	Class F, Optionally Class H
<b>Weather Protection</b>	IP67, Optionally IP67M, IP68
<b>Approval</b>	Indian, European, SIL
<b>Voltage Variation</b>	Refer to Voltage Variation Table (on page 428B)
<b>Duty Cycle</b>	100% (ED)
<b>Ambient Temperature</b>	Class F, Power ≤ 13W, -40 °C to 75 °C Class H, Power ≤ 13W, -40 °C to 100 °C, Power ≥ 13W, -40 °C to 75 °C

## WEIGHT IN kg

Size	Al	SS
I	0.5	1.2
II	0.8	1.7
III	0.6	1.4
IV	0.8	1.6

## APPLICATION



INDOOR



OUTDOOR

## TERMINAL BOX SOLENOID TYPE : 16, 19

### POWER

Voltage	Solenoid		Power (VA)							
	Size	Core Dia	0.4②	1.8②	3.5	5	8	12	13	30
6	I	14					▲			
	II	18					✓		▲	
	III	13	✓							
	III	14		✓	✓		▲			
	IV	14		✓						
12	I	14		✓			▲	▲		
	II	18					✓		▲	✓
	III	13	✓							
	III	14		✓	✓		▲			
	IV	14		✓						
24	I	14		✓			▲	▲		
	II	18					✓		▲	✓
	III	13	✓							
	III	14		✓	✓	✓	▲			
	IV	14		✓						
48	I	14					▲	▲		
	II	18							▲	✓
	III	14		✓	✓		▲			
	IV	14		✓						
110-120	I①	14				✓	▲	▲		
	II	18					✓		▲	✓
	III	14			✓		▲			
220-240	I①	14				✓	▲	▲		
	II	18					✓		▲	✓
	III	14					▲			
256②	II	18					✓		▲	✓
	III	14				✓	▲			
440④	III	14						▲		

▲ Standard

✓ Optional Available

① Select Current 50 Hz or 60 Hz

② Select Current DC

④ Select Current 50 Hz

### STANDARD POWER

Size	Current	Standard Power W, VA
I	AC	6, 12
	DC	8, 8
II	AC	13, 13
	DC	13, 13
III	AC	6, 12
	DC	8, 8



# TERMINAL BOX SOLENOID TYPE : 16, 19

## SOLENOID ORDERING CODE

III - 24DC - 16 - A - SS - LD - LW5 - H

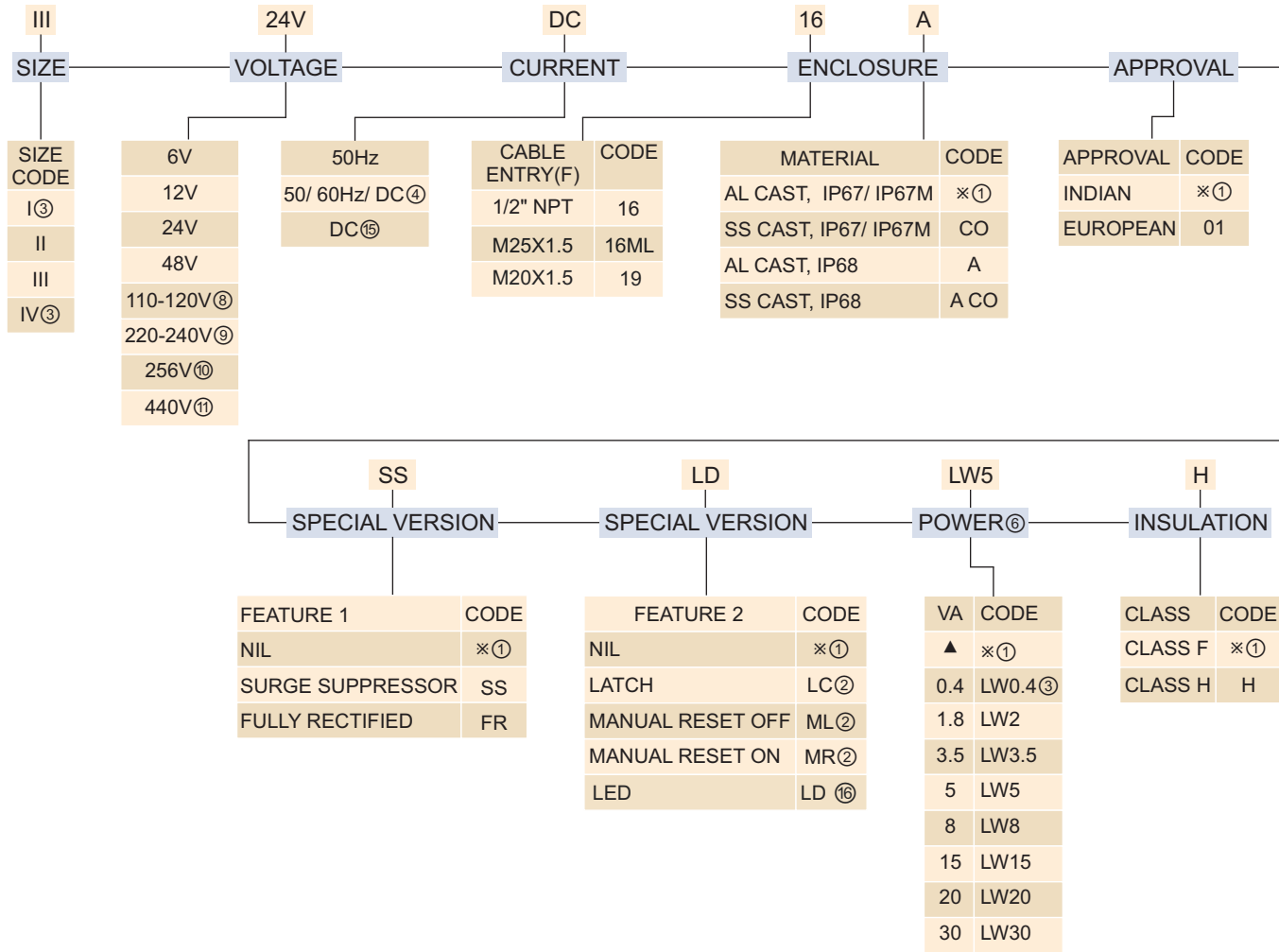

NOTE : ① Do not specify

② Voltage 24V, 110-120V, 220-240V current 50/ 60 Hz/ DC power standard size II/ III

③ Current 50/ 60 Hz/ DC Special version FR can not be opted

④ Select Option FR for 50/ 60 Hz/ DC current

⑥ Refer Power table on page 428A

⑧ 110-120V 50 Hz Solenoid can be used for 110V 50 Hz, 120V 60 Hz

⑨ 220-240V Solenoid can be used for 220-240V 50 Hz, 240V 60 Hz

⑩ Only for DC current

⑪ Current 50 Hz, Size III

⑫ 110-120V, 220-240V, DC can be supplied in Solenoid size II, III

⑬ Size II & III Only

## VOLTAGE VARIATION (For Continuous Duty only)

Rated Voltage	Operating Voltage
6	4.8V to 7.2V
12	9.6V to 14.4V
24	19.2V to 28.8V
48	38.4V to 57.6V
110-120	88V to 132V
220-240	176V to 264V
256	192V to 280V
440	350V to 480V



## TERMINAL BOX SOLENOID TYPE : 16, 19

### DIMENSION

### SOLENOID TYPE : 16

#### CABLE ENTRY M20X1.5

**CABLE ENTRY**  
Include drwg. with adopter  
16 MS  
16

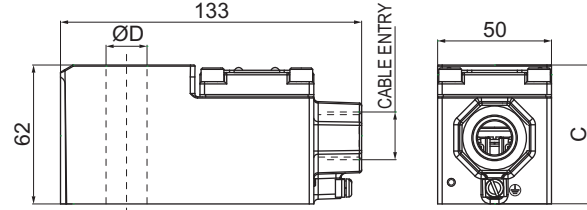
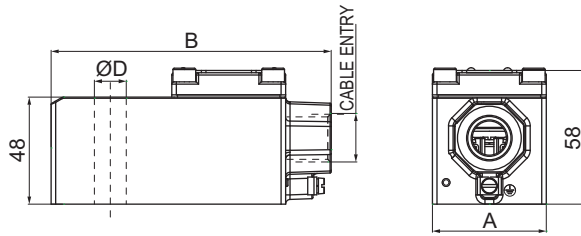

SIZE	A	B	ØD
I	42	116	14
III	50	124	14
III	50	124	13

SIZE	C	ØD
II	61	18
IV	51	14

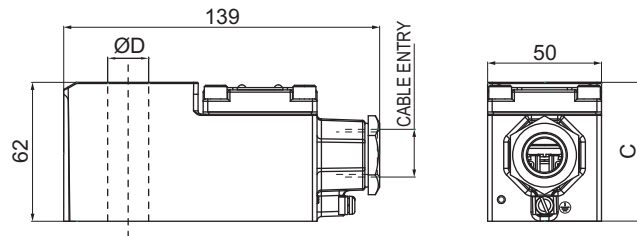
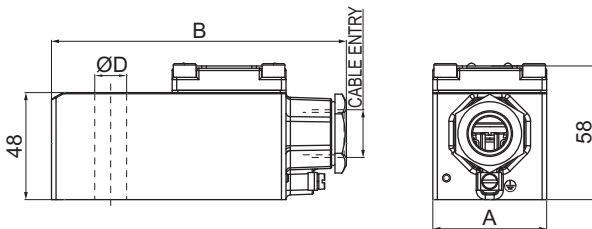

#### CABLE ENTRY M20X1.5 & 1/2" NPT (With Adopter)



SIZE	A	B	ØE
I	42	122	14
III	50	130	14
III	50	130	13

SIZE	C	ØD
II	61	18
IV	51	14

## OBSELETE PRODUCTS AND ITS INTERCHANGEABILITY

 <p>Replace with Solenoid code 16 or 16MS along with Guide and Plunger assembly</p>	 <p>Solenoid Type 19 Replace with coil code 16MS</p>			
--	---	--	--	--

## TERMINAL BOX (BCE) TYPE : 17

### CIRCUIT DIAGRAM

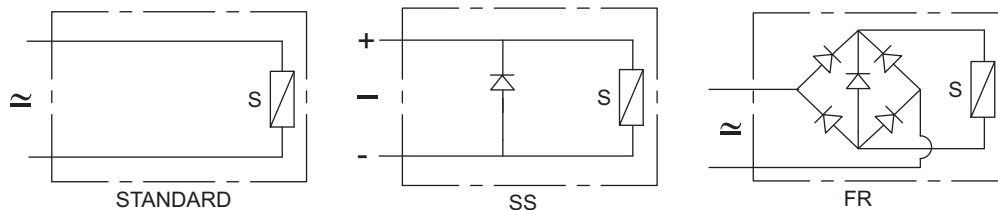

### FEATURES

- Designed for extreme environmental condition
- Large terminals for easy connection
- Constructed for lowest temperature rise thus longer life
- 'O' Energiser for higher magnetic linkage
- Wider voltage variation
- Bottom Cable entry to avoid rain or process fluid entering into the termination area.
- For ease of operation and maintenance LED can be provided to confirm availability of voltage to the coil terminals
- UL Listed, file number E342217
- Dual gasket for better weather proof protection

UL



### SPECIFICATION

<b>Size</b>	II - 18 mm, III - 13 mm, III & IV - 14 mm	
<b>Voltage</b>	6 V, 12 V, 24 V, 110 V, 120 V, 220 V, 256 V	
<b>Current</b>	50 Hz, 60 Hz, DC, 50/ 60 Hz/ DC	
<b>Enclosure</b>	<b>Cable Entry</b>	M25 X 1.5, Adopted to M20 X 1.5 or 1/2" NPT
	<b>Material</b>	Aluminum Cast colour Blue polyester powder coat, Stainless Steel Cast
<b>Options</b>	Surge Suppressor (SS), Fully Rectified (FR), Low Power (LW), Manual Reset (MR)	
<b>Power</b>	Refer to table "Power" on page 428E	
<b>Insulation Class</b>	Class H	
<b>Weather Protection</b>	Type 3, 35, 4, 4X, 6, 6P	
<b>Approval</b>	UL Listed	
<b>Voltage Variation</b>	Refer to Voltage Variation table on page 428F	
<b>Duty Cycle</b>	100% (ED)	
<b>Ambient Temperature</b>	Power ≤ 20W, -60 °C to 100 °C, Power ≥ 20W, -60 °C to 75 °C	

### WEIGHT IN kg

Size	Al/ kg	SS/ kg
II	0.9	1.6
III	0.8	1.4

### APPLICATION



INDOOR



OUTDOOR

## TERMINAL BOX (BCE) TYPE : 17

### POWER

Voltage	Solenoid		Power (VA)							
	Size	Core Dia	0.4②	1.8②	3.5	5	8	12	13	30
6	II	18					✓		▲	
	III	13	✓							
	III	14		✓	✓		▲			
	IV	14		✓						
12	II	18					✓		▲	✓
	III	13	✓							
	III	14		✓	✓		▲			
	IV	14		✓						
24	II	18					✓		▲	✓
	III	13	✓							
	III	14		✓	✓		▲			
	IV	14		✓						
48	II	18							▲	
	III	13					▲			
110-120	II	18					✓		▲	✓
	III	13								
	III	14				✓	▲	▲		
	IV	14								
220-240	II	18					✓		▲	✓
	III	14			✓		▲	▲		
	IV	14								
256②	II	18					✓		▲	✓
	III	14					▲			
	IV	14								

- ▲ Standard
- ✓ Optional Available
- ② Only for DC Current

### STANDARD POWER

Size	Current	Standard Power W, VA
I	AC	6, 12
	DC	8, 8
II	AC	13, 13
	DC	13, 13
III	AC	6, 12
	DC	8, 8

**TERMINAL BOX (BCE) TYPE : 17**

**SOLENOID ORDERING CODE**

**III-24V-DC-17-CO-SS-LD-LW5-H-02**

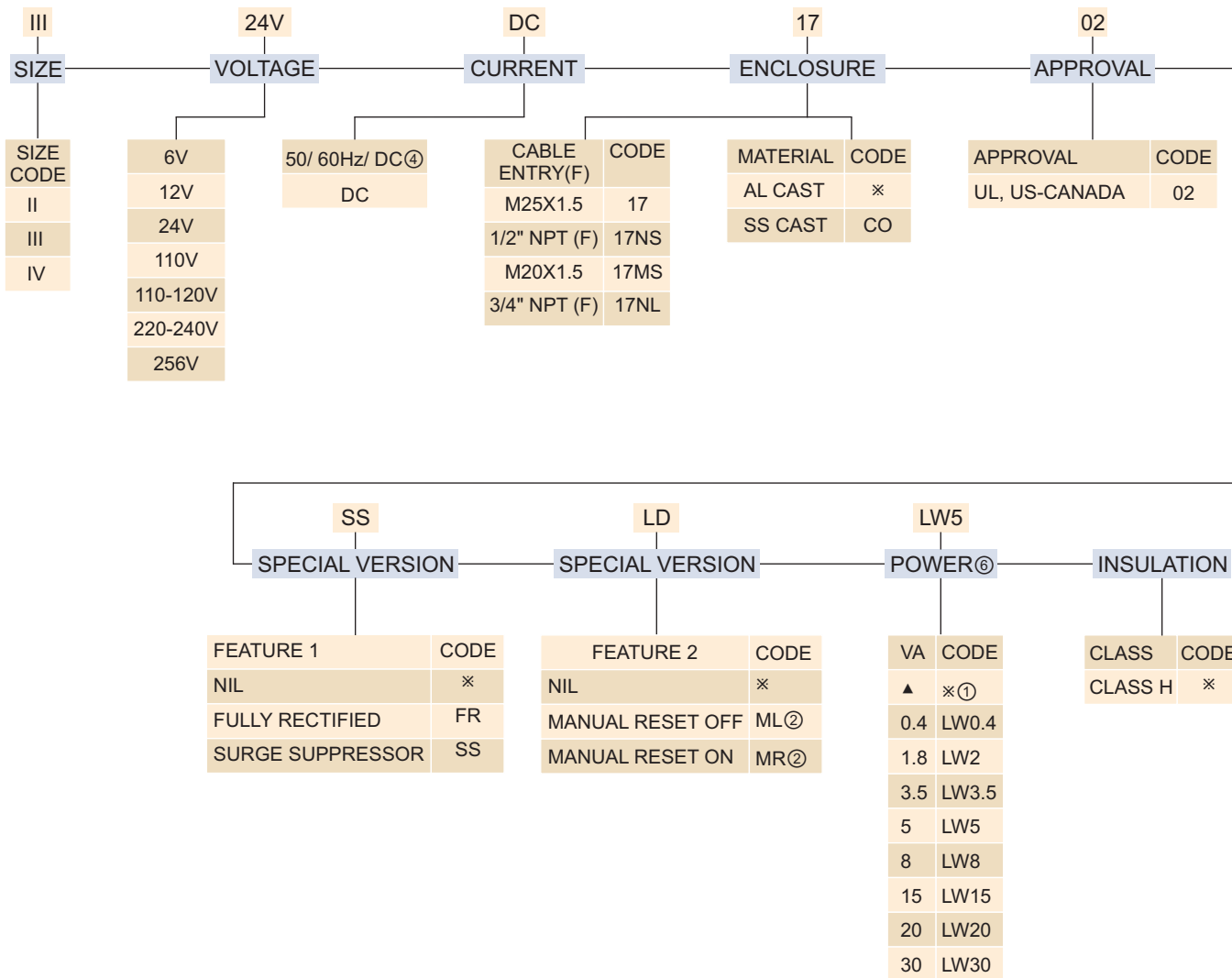

NOTE : ① Do not specify

② Available in size II and III select power standard voltage 24V, 110-120V, 220-240V

④ Select special version FR

⑥ Refer Power table on page 428E for size, Voltage and Power

⑧ 110-120V 50 Hz Solenoid can be used for 110V 50 Hz, 120V 60 Hz

⑨ 220-240V Solenoid can be used for 220-240V 50 Hz, 240V 60 Hz

**VOLTAGE VARIATION** (For Continuous Duty only)

Rated Volatge	Operating Voltage
6	4.8V to 7.2V
12	9.6V to 14.4V
24	19.2V to 28.8V
48	38.4V to 57.6V
110-120	88V to 132V
220-240	176V to 264V
256	192V to 280V

## TERMINAL BOX (BCE) TYPE : 17

### MARKING

**ROTEX AUTOMATION LIMITED**  
www.rotexautomation.com

**TYPE**  
3, 3R, 3S, 4, 4X, 6 & 6P

MODEL : III-110-120V-50Hz-60Hz/DC-7-02-FR-LW5

SR. NO. : 15100100 - 07/14-081

Ambient Temperature  
-60 °C to 100 °C POWER ≤ 20W  
-60 °C to 70 °C > 20W POWER ≤ 30W

DUTY CYCLE : CONTINUOUS

### DIMENSION SOLENOID TYPE : 17

#### WITH CABLE ENTRY M25X1.5

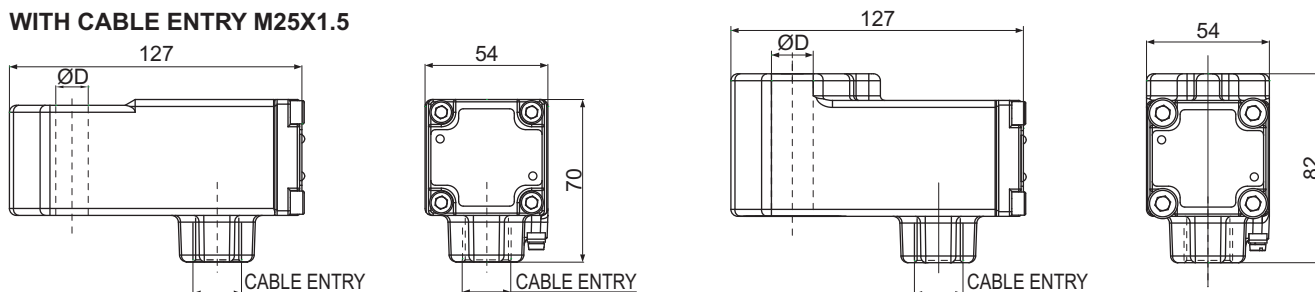

	ØD
III	13
III	14

	ØD
II	18
IV	14

#### CABLE ENTRY M20X1.5, 1/2" NPT(F) (With Adopter)

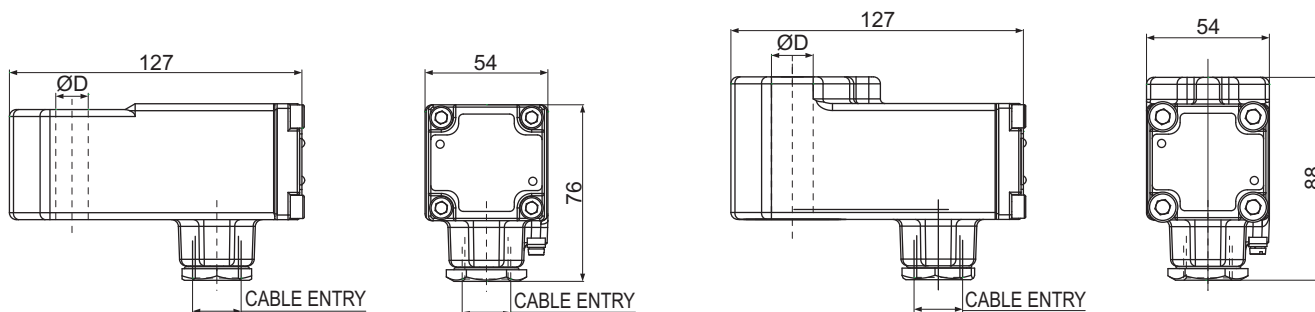

	ØD
III	13
III	14

	ØD
II	18
IV	14

### OBSELETE PRODUCTS AND ITS INTERCHANGEABILITY

--	--	--	--

**EXPLOSION PROOF SOLENOID TYPE : 37, 39**

**Ex d**

**CIRCUIT DIAGRAM**

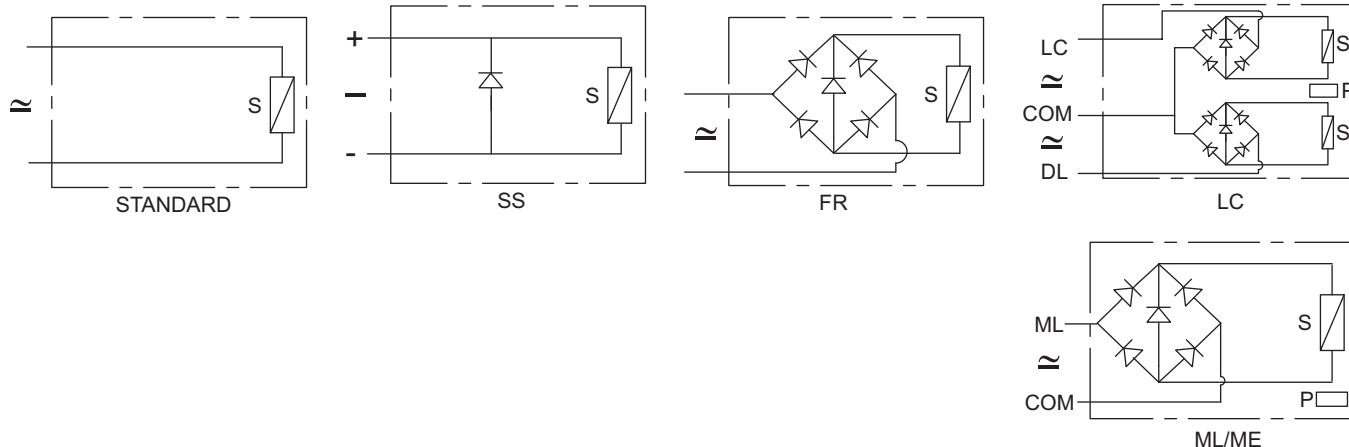

**FEATURES**

- Designed for extreme environmental condition
- With Integrated terminal box and Horizontal cable entry
- Large terminals for easy connections
- Constructed for lowest temperature rise thus longer life
- 'O' Energiser for higher magnetic linkage
- Wider voltage variation
- Surger Suppressor Provided
- Dual gasket



**SPECIFICATION**

<b>Size</b>	I- 14 mm, II- 18 mm, III- 13 mm, III & IV - 14 mm
<b>Voltage</b>	6 V, 12 V, 24 V, 48 V, 110 V, 120 V, 220 V, 256 V
<b>Current</b>	50 Hz, 60 Hz, DC, 50/ 60/ DC
<b>Enclosure</b>	<b>Cable Entry</b> M25X1.5, Adopted to M20X1.5 or 1/2" NPT ((INDIAN Approval) M20X1.5, 1/2" NPT (37-01, 39-01) (Other than INDIAN Approval) <b>Material</b> Aluminum Cast, Polyester Powder coat, Colour Red Stainless Steel Cast, Painted Optionally Grey Polyester Powder coat
<b>Options</b>	Corrosive Enviornment (CO), Manual Reset ON (MR ON), Manual Reset OFF (MR OFF), Low Power (LW), Latch (LC), Surge Suppressor(SS), Fully Rectified (FR)
<b>Power</b>	Refer to table "Power" on page 429A
<b>Insulation Class</b>	Class F optionally Class H (INDIAN Approval) Class H (Other than INDIAN Approval)
<b>Weather Protection</b>	IP66, IP67, IP67M (Refer marking on page 429C)
<b>Approval</b>	INDIAN, ATEX, CU-TR, INMETRO, CCOE, DGMS, SIL
<b>Voltage Variation</b>	Refer to Voltage Variation table on page 429B
<b>Duty Cycle</b>	100% (ED)
<b>Ambient Temperature</b>	Refer to Ambient temperature table on page 429C

**WEIGHT IN kg**

Size	Al	SS
I	0.5	1.2
II	0.8	1.7
III	0.6	1.4
IV	0.8	1.6

**APPLICATION**



**INDOOR**



**OUTDOOR**



## POWER

Voltage	Solenoid		Power (VA)							
	Size	Core Dia	0.4 <sup>②</sup>	1.8 <sup>②</sup>	3.5	5	8	12	13	30
6	I	14					▲			
	II	18					✓		▲	
	III	13	✓							
	III	14		✓	✓		▲			
	IV	14		✓						
12	I	14		✓ <sup>③</sup>			▲	▲		
	II	18					✓		▲	✓
	III	13	✓							
	III	14		✓	✓		▲			
	IV	14		✓						
24	I	14		✓ <sup>③</sup>			▲	▲		
	II	18					✓		▲	✓
	III	13	✓							
	III	14		✓	✓	✓	▲			
	IV	14		✓						
48	I	14		✓ <sup>③</sup>			▲	▲		
	II	18							▲	✓
	III	14		✓	✓		▲			
	IV	14		✓						
110-120	I <sup>①</sup>	14				✓ <sup>③</sup>		▲		
	II	18					✓		▲	✓
	III	14			✓	✓	▲			
220-240	I <sup>①</sup>	14						▲		
	II	18					✓		▲	✓
	III	14				✓	▲			
256 <sup>②</sup>	II	18					✓		▲	✓
	III	14					▲			
440 <sup>④</sup>	III	14						▲		

▲ Standard

✓ Optional Available

① Current 50 Hz or 60 Hz

② Only for DC Current

③ Should be Opted for 3/2 &amp; 5/2 pilot operated valve

④ Current 50 Hz only

## STANDARD POWER

Size	Current	Standard Power W, VA
I	AC	6, 12
	DC	8, 8
II	AC	13, 13
	DC	13, 13
III	AC	6, 12
	DC	8, 8



**EXPLOSION PROOF SOLENOID TYPE : 37, 39**

**Ex d**

**SOLENOID ORDERING CODE**

**III-24V-DC-37-CO-SS-LD-LW5-H**

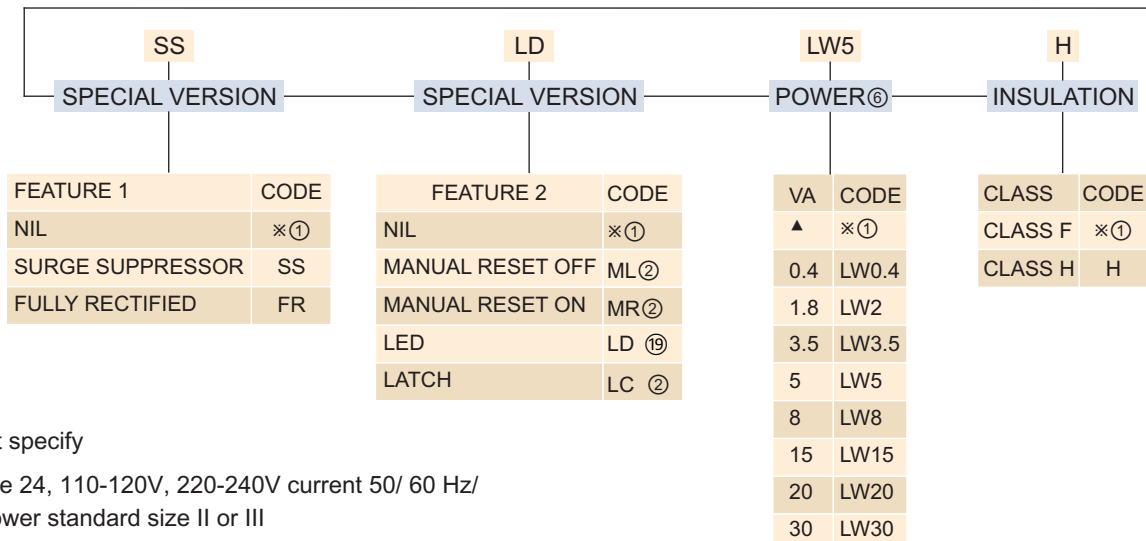
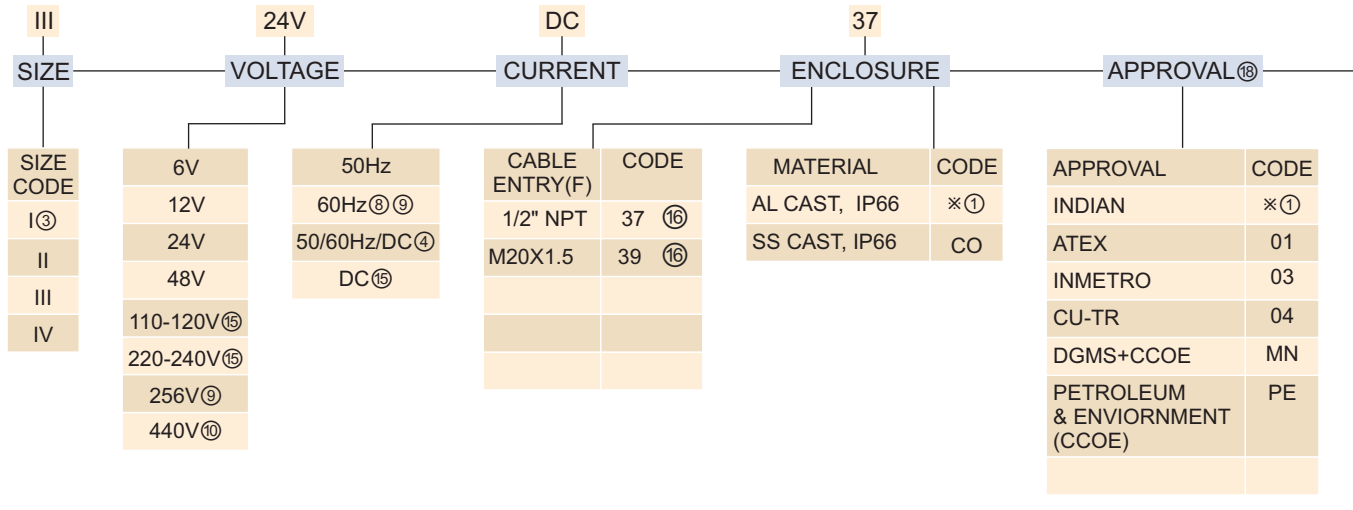

NOTE : ① Do not specify

② Voltage 24, 110-120V, 220-240V current 50/ 60 Hz/ DC Power standard size II or III

③ Current 50/ 60 Hz/ DC & Special version FR can not be opted

④ Select special version FR

⑥ Refer Power table on page 429A

⑧ 110-120V 50 Hz Solenoid can be used for 110V 50 Hz, 120V 60 Hz

⑨ 220-240V 50 Hz Solenoid can be used for 240V 60 Hz, 220-240V 50 Hz

⑩ 50 Hz current, Size III only

⑮ Current DC size II, III

⑮ IP67 Certified by IS, CCOE/ PESO, D MS

⑮ Add SL for SIL capable certified coil

⑲ Size II & III Only

**VOLTAGE VARIATION** (For Continuous Duty only)

Rated Voltage	Operating Voltage
6	4.8V to 7.2V
12	9.6V to 14.4V
24	19.2V to 28.8V
48	38.4V to 57.6V
110-120	88V to 132V
220-240	176V to 264V
256	205V to 280V
440	350V to 480V

**APPROVAL**

Approval	certifying Agencies	reference Number
INDIAN	CMRI	KLPL/Ex/R/12-007
	KLPL (Re-Validated)	CMRI/TC/P/H-1415
BIS INDIAN		7229976
CCOE/ PESO INDIAN		P-218046/1
DGMS INDIAN		230 of 2011
EUROPEAN/ ATEX	CESI, Italy	CESI 03 ATEX 344 Extension No. 01/12
INMETRO	CEPEL	CEPEL 08-1717X
CU-TR		RU C-IN.Г508.B.01100



**MARKING**

Marking	Ambient Temperature
<b>ATEX</b>	
II 2GD Ex d IIC T6 Gb Ex tb IIIC T80 °C Db IP66	- 40 °C ≤ Ta < 35 °C
II 2GD Ex d IIC T5 Gb Ex tb IIIC T95 °C Db IP66	- 40 °C ≤ Ta ≤ 50 °C
II 2GD Ex d IIC T4 Gb Ex tb IIIC T130 °C Db IP66	- 40 °C ≤ Ta ≤ 60 °C
INDIAN, CCOE/PESO, DGMS Refer to Table for Ambient Temp.	
Ex d IIC Tx IP67	- 20 °C ≤ Ta ≤ AA °C
<b>INMETRO</b>	
II 2GD Ex d IIC T6 Gb Ex tb IIIC T85 °C Db IP66	- 40 °C ≤ Ta < 35 °C
II 2GD Ex d IIC T5 Gb Ex tb IIIC T100 °C Db IP66	- 40 °C ≤ Ta ≤ 50 °C
II 2GD Ex d IIC T4 Gb Ex tb IIIC T135 °C Db IP66	- 40 °C ≤ Ta ≤ 60 °C
<b>CU-TR</b>	
1 Ex d IIC T6 Gb X/Ex tb IIIC T80 °C Db	- 40 °C to 35 °C
1 Ex d IIC T5 Gb X/Ex tb IIIC T95 °C Db	- 40 °C to 50 °C
1 Ex d IIC T4 Gb X/Ex tb IIIC T130 °C Db	- 40 °C to 60 °C

**AMBIENT TEMPERATURE**

(INDIAN Approval)

SIZE	MAX. POWER	MAX. AMBIENT TEMP. °C		
		T6 (80)	T5 (95)	T4 (130)
I	5	65	70	-
	8	60	70	-
III	5	70	-	-
	8	60	70	-
	15	50	65	70
II	8	65	70	-
	10	60	70	-
	13	60	70	-
	20	55	70	-
IV	30	40	55	70
	5	70	-	-
	11	65	70	-

**DIMENSION**

**SOLENOID TYPE : 37 & 39**

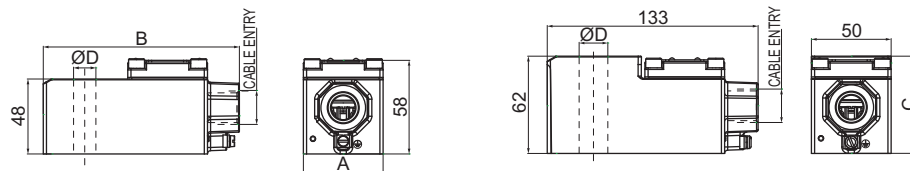

SIZE	A	B	ØD	COIL TYPE	CABLE ENTRY	APPROVAL INDIAN	OTHER THAN INDIAN	SIZE	C	ØD
I	42	116	14	37	M25X1.5(F)	✓		II	61	18
III	50	124	14	37	1/2"NPT(F)		✓	IV	51	14
III	50	124	13	39	M20X1.5(F)		✓			
				37NS	1/2"NPT(F)	✓				
				37MS	M20X1.5(F)	✓				

**CABLE ENTRY M20X1.5, 1/2" NPT(F) (With Ex Adopter) (INDIAN Approval)**

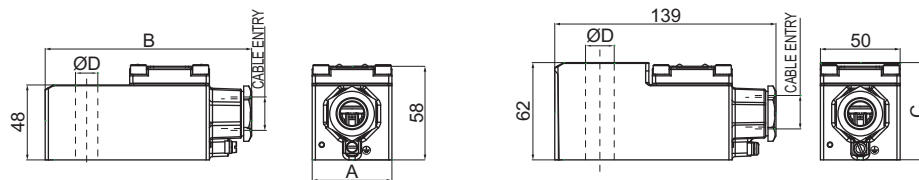

SIZE	A	B	ØD	COIL TYPE	CABLE ENTRY	APPROVAL INDIAN	SIZE	C	ØD
I	42	122	14	37	1/2"NPT(F)	✓	II	61	18
III	50	130	14	39	M20X1.5(F)	✓	IV	51	14
III	50	130	13	37MS	M20X1.5(F)	✓			
				37NS	1/2"NPT(F)	✓			

**OBSELETE PRODUCTS AND ITS INTERCHANGEABILITY**

Replace Solenoid code 37 or 37MS along with Guide & Plunger assembly	Replace Solenoid code 37 or 37MS along with Guide & Plunger assembly	Solenoid code 39 replace with Solenoid code 37MS		



**CIRCUIT DIAGRAM**

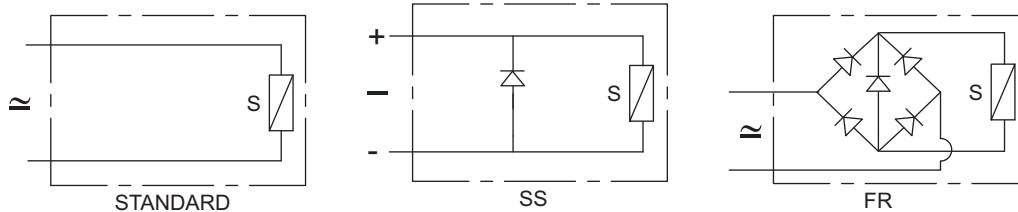

**FEATURES**

- Designed for extreme environmental condition
- Constructed for lowest temperature rise thus longer life
- 'O' Energiser for higher magnetic linkage
- Wider voltage variation
- UL Listed file number (applied for)

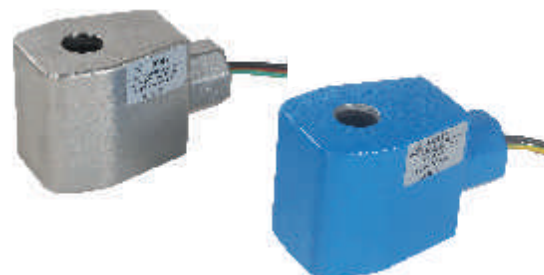

**SPECIFICATION**

<b>Size</b>	II- 18 mm, III- 13 mm, III & IV - 14 mm
<b>Voltage</b>	6 V, 12 V, 24 V, 110 V, 120 V, 220 V, 256 V
<b>Current</b>	50 Hz, 60 Hz, DC, 50/ 60 Hz/ DC
<b>Enclosure</b>	<b>Cable Entry</b> 1/2" NPT (F) <b>Material</b> Aluminum Cast, Polyester Powder coated, Colour Blue Stainless Steel casting
<b>Options</b>	Surge Suppressor(SS), Fully Rectified (FR), Manual Reset ON (MR)
<b>Power</b>	Refer to table "Power" on Page 431A
<b>Insulation Class</b>	Class H
<b>Weather Protection</b>	Type 3, 3S, 3R, 4, 4X, 6, 6P* 7 & 9
<b>Approval</b>	UL Listed
<b>Voltage Variation</b>	Refer to Voltage Variation Table (on page 431B)
<b>Duty Cycle</b>	100% (ED)
<b>Ambient Temperature</b>	Power ≤ 20W, -60 °C to 100 °C, Power ≥ 20W, -60 °C to 75 °C

\* Applied for

**WEIGHT IN kg**

Size	Al/ kg	SS/ kg
II	0.7	0.9
III	0.5	

**APPLICATION**



INDOOR



OUTDOOR

## POWER

Voltage	Solenoid		Power (VA)						
	Size	Core Dia	0.4②	1.8②	3.5	5	8	13	30
6	II	18		✓			✓	▲	
	III	13	✓						
	III	14			✓		▲		
	IV	14		✓					
12	II	18		✓			✓	▲	✓
	III	13	✓						
	III	14			✓		▲		
	IV	14		✓					
24	II	18		✓			✓	▲	✓
	III	13	✓						
	III	14			✓	✓	▲		
	IV	14		✓					
110-120	II	18					✓	▲	✓
	III	13							
	III	14			✓	✓	▲		
220-240	II	18					✓	▲	✓
	III	14				✓	▲		
256②	II	18					✓	▲	✓
	III	14					▲		

- ▲ Standard
- ✓ Optional Available
- ② Only for DC Current

## STANDARD POWER

Size	Current	Standard Power W, VA
I	AC	6, 12
	DC	8, 8
II	AC	13, 13
	DC	13, 13
III	AC	6, 12
	DC	8, 8

**EXPLOSION PROOF FLYING LEAD WITH CABLE ENTRY SOLENOID TYPE : 56**

Ex d

**SOLENOID ORDERING CODE III-24V-DC-56-H-01**

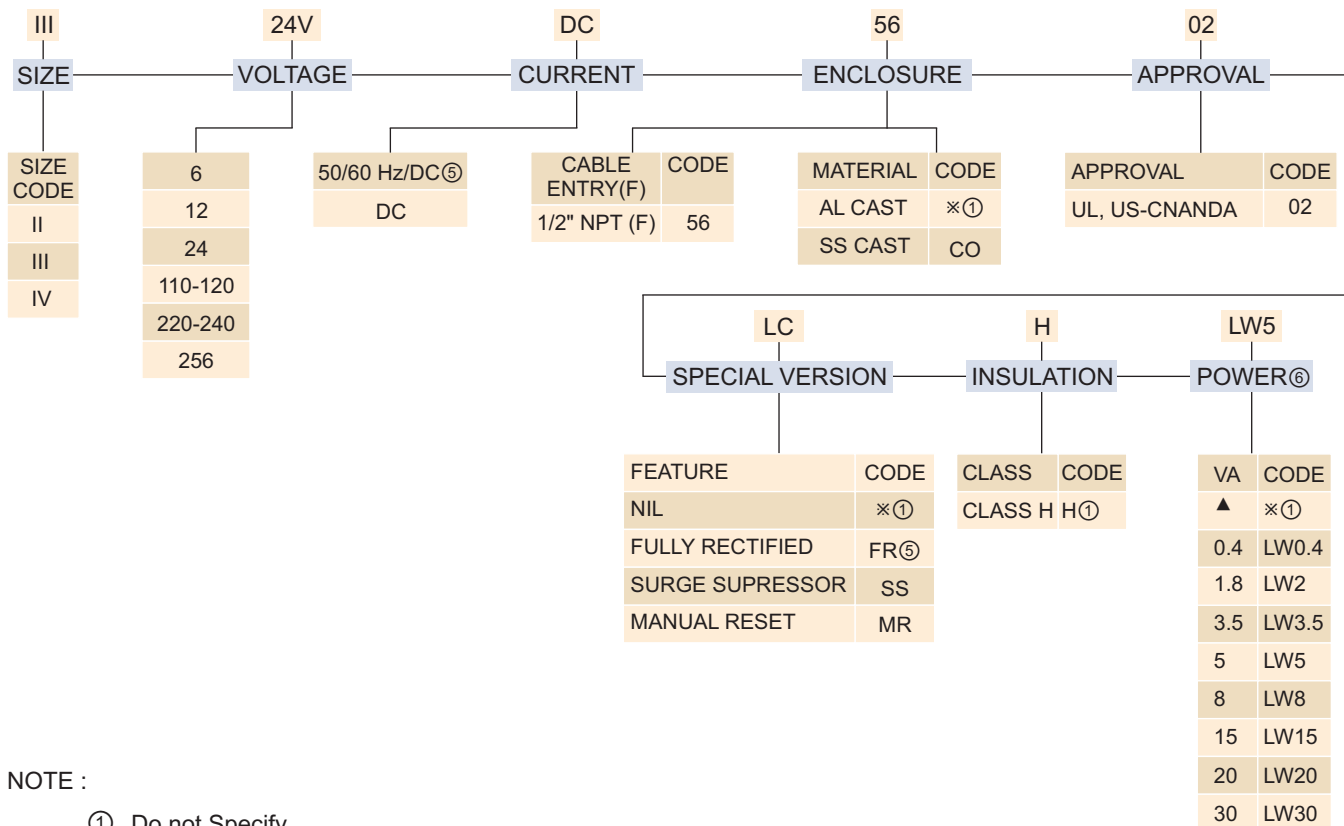

NOTE :

- ① Do not Specify
- ⑤ Solenoid suitable for 50 Hz/ 60 Hz/ DC current, select special version FR
- ⑥ Refer Power table on page 430A

**VOLTAGE VARIATION** (For Continuous Duty only)

Rated Voltage	Operating Voltage
6	4.8V to 7.2V
12	9.6V to 14.4V
24	19.2V to 28.8V
48	38.4V to 57.6V
110-120	88V to 132V
220-240	176V to 264V
256	192V to 280V

**DIMENSION**

**SOLENOID TYPE : 56**

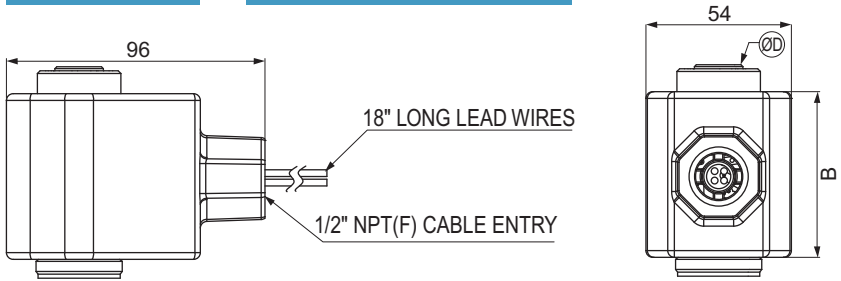

SIZE	B	ØD*
II	61	18
III	47	14
IV	61	14
III	47	13

**EXPLOSION PROOF SOLENOID TYPE : 58 & 58-LT**

**Ex emb**

**CIRCUIT DIAGRAM**

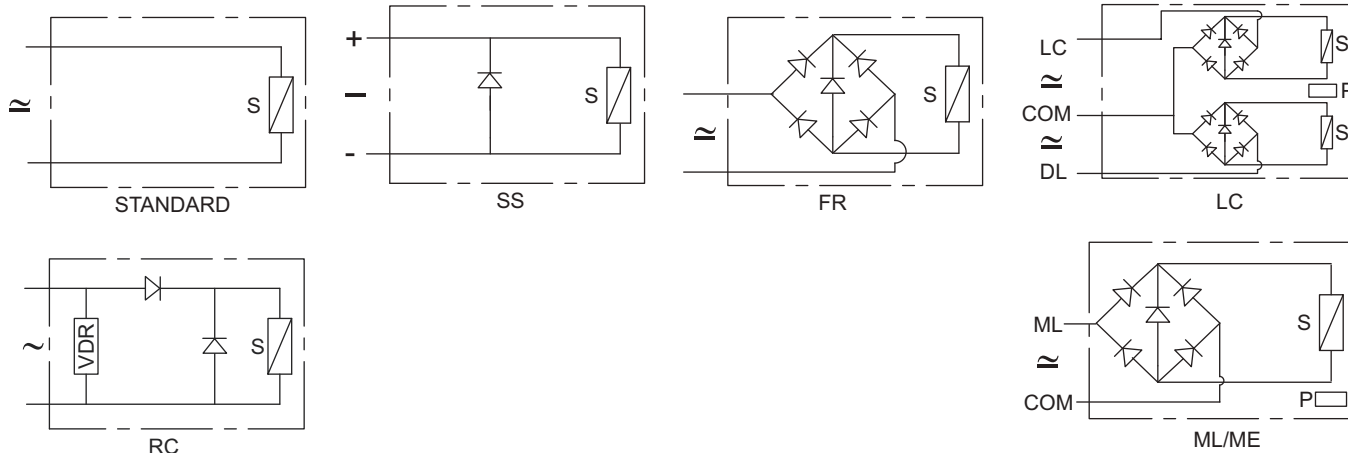

**FEATURES**

- Designed for extreme environmental condition
- Integrated terminal box having Horizontal cable entry
- Large terminals for easy connections
- Constructed for lowest temperature rise thus longer life
- 'O' Energiser for higher magnetic linkage
- Wider voltage variation
- Can in be installed zone 1, 2, 21, 22



**SPECIFICATION**

<b>Size</b>	I- 14 mm, II- 18 mm, III- 13 mm, III & IV - 14 mm
<b>Voltage</b>	6 V, 12 V, 24 V, 48 V, 110 V, 120 V, 230 V, 256 V
<b>Current</b>	50 Hz, 60 Hz, DC, 50-60Hz DC
<b>Enclosure</b>	<b>Cable Entry</b> M25X1.5, Adopted to M20X1.5 or 1/2" NPT <b>Material</b> Aluminum Cast, Polyester Powder coated, Colour Black Stainless Steel Cast
<b>Options</b>	Corrosive Environment (CO), Manual Reset ON (MR), Manual Reset, OFF (ML), Low Power (LW), Latch (LC), Surge Suppressor(SS), Fully Rectified (FR), Half Rectified (RC)
<b>Power</b>	Refer to table "Power" on page 430E
<b>Insulation Class</b>	Class H
<b>Weather Protection</b>	IP67
<b>Approval</b>	ATEX
<b>Voltage Variation</b>	Refer to Voltage Variation table on page 430F
<b>Duty Cycle</b>	100% (ED)
<b>Ambient Temperature</b>	-60 °C to 70 °C Refer to Marking table on page 430G

**WEIGHT IN kg**

Size	Al	SS
I	0.5	1.2
II	0.8	1.7
III	0.7	1.4
IV	0.8	1.6

**APPLICATION**



**INDOOR**



**OUTDOOR**

## POWER

Voltage	Solenoid		Power (VA)							
	Size	Core Dia	1.0②	1.8②	3.5	5	8	12	13	30
6 ②	I	14					▲			
	II	18							▲	
	III	13								
	III	14								
	IV	14								
12	I ⑤	14					▲			
	II	18							▲	
	III	13	√③							
	III	14		√③	✓					
	IV	14		✓						
24	I ⑤	14		√③			▲	▲		
	II	18					✓		▲	✓
	III	13	√③							
	III	14		√③	✓	✓	▲			
	IV	14		✓						
48	I ⑤	14					▲			
	II	18							▲	
	III	14					▲			
	IV	14								
110-120	I①⑤	14						▲		
	II	18					✓		▲	✓
	III	14			✓	✓	▲			
220-240	I ①⑤	14						▲		
	II	18					✓		▲	✓
	III	13								
	III	14				✓	▲			
256②	II	18							▲	✓
	III	14					▲			

▲ Standard

✓ Optional Available

① Current 50 Hz or 60 Hz

② Only for DC Current

③ Should be Opted for 3/2 &amp; 5/2 pilot operated valve

④ Current 50 Hz only

⑤ Current 50 Hz, 60Hz or DC

## STANDARD POWER

Size	Current	Standard Power W, VA
I	AC	6, 12
	DC	8, 8
II	AC	13, 13
	DC	13, 13
III	AC	6, 12
	DC	8, 8



**EXPLOSION PROOF SOLENOID TYPE : 58**

**Ex emb**

**SOLENOID ORDERING CODE III-24V-DC-58-CO-SS-LD-LW5**

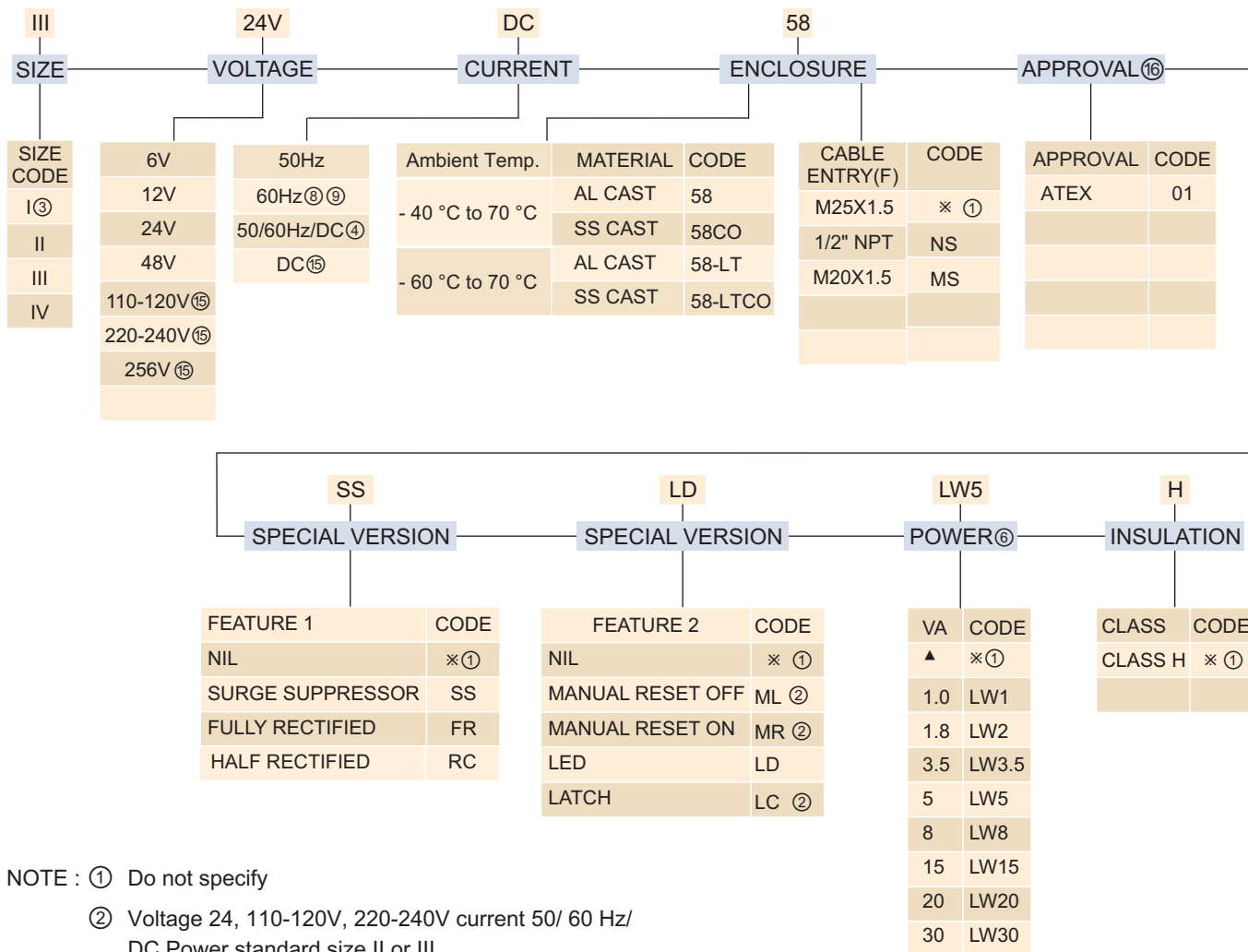

NOTE : ① Do not specify

② Voltage 24, 110-120V, 220-240V current 50/ 60 Hz/ DC Power standard size II or III

③ Current 50 Hz/ 60 Hz or DC, Special version FR can not be opted

④ Select special version FR, Size II, III, IV

⑥ Refer Power table on page 430E

⑧ 110-120V 50 Hz Solenoid can be used for 110V 50 Hz, 120V 60 Hz

⑨ 220-240V 50 Hz Solenoid can be used for 240V 60 Hz, 220-240V 50 Hz

⑮ Current DC size II, III, IV

⑯ Add SL for SIL capable certified coil

**VOLTAGE VARIATION** (For Continuous Duty only)

Rated Voltage	Operating Voltage
6	4.8V to 7.2V
12	9.6V to 14.4V
24	19.2V to 28.8V
48	38.4V to 57.6V
110-120	88V to 132V
220-240	176V to 264V
256	205V to 280V

**APPROVAL**

Approval	Certifying Agencies	Reference Number
EUROPEAN/ ATEX	TEKNIKA INSPECIA, a.s.	1408X

MARKING

SOLENOID TYPE 58

Size III 15W Coil

EX e mb IIC T6 - T4 Gb IP67  
 Ex tb IIIC T6 - T4 °C Db IP67  
 -40 °C ≤ Ta ≤ 50 °C for T6  
 -40 °C ≤ Ta ≤ 65 °C for T5  
 -40 °C ≤ Ta ≤ 70 °C for T4

Size III 5W Coil

EX e mb IIC T6 Gb IP67  
 Ex tb IIIC T6 °C Db IP67  
 -40 °C ≤ Ta ≤ 70 °C for T6

Size III 8W, Size II 10W  
 Size I 8W, Size II 13W

EX e mb IIC T6 - T5 Gb IP67  
 Ex tb IIIC T6 - T5 °C Db IP67  
 -40 °C ≤ Ta ≤ 60 °C for T6  
 -40 °C ≤ Ta ≤ 70 °C for T5

Size II 20W Coil

EX e mb IIC T6 - T5 Gb IP67  
 Ex tb IIIC T6 - T5 °C Db IP67  
 -40 °C ≤ Ta ≤ 55 °C for T6  
 -40 °C ≤ Ta ≤ 70 °C for T5

Size II 8W,  
 Size I 5W, Size IV 11W

EX e mb IIC T6 - T5 Gb IP67  
 Ex tb IIIC T6 - T5 °C Db IP67  
 -40 °C ≤ Ta ≤ 60 °C for T6  
 -40 °C ≤ Ta ≤ 70 °C for T5

Size II 30W Coil

EX e mb IIC T6 - T4 Gb IP67  
 Ex tb IIIC T6 - T4 °C Db IP67  
 -40 °C ≤ Ta ≤ 40 °C for T6  
 -40 °C ≤ Ta ≤ 55 °C for T5  
 -40 °C ≤ Ta ≤ 70 °C for T4

SOLENOID TYPE 58-LT

Size III 15W Coil

EX e mb IIC T6 - T4 Gb IP67  
 Ex tb IIIC T6 - T4 °C Db IP67  
 -60 °C ≤ Ta ≤ 50 °C for T6  
 -60 °C ≤ Ta ≤ 65 °C for T5  
 -60 °C ≤ Ta ≤ 70 °C for T4

Size III 5W Coil

EX e mb IIC T6 Gb IP67  
 Ex tb IIIC T6 °C Db IP67  
 -60 °C ≤ Ta ≤ 70 °C for T6

Size III 8W, Size II 10W  
 Size I 8W, Size II 13W

EX e mb IIC T6 - T5 Gb IP67  
 Ex tb IIIC T6 - T5 °C Db IP67  
 -60 °C ≤ Ta ≤ 60 °C for T6  
 -60 °C ≤ Ta ≤ 70 °C for T5

Size II 20W Coil

EX e mb IIC T6 - T5 Gb IP67  
 Ex tb IIIC T6 - T5 °C Db IP67  
 -60 °C ≤ Ta ≤ 55 °C for T6  
 -60 °C ≤ Ta ≤ 70 °C for T5

Size II 8W,  
 Size I 5W, Size IV 11W

EX e mb IIC T6 - T5 Gb IP67  
 Ex tb IIIC T6 - T5 °C Db IP67  
 -60 °C ≤ Ta ≤ 60 °C for T6  
 -60 °C ≤ Ta ≤ 70 °C for T5

Size II 30W Coil

EX e mb IIC T6 - T4 Gb IP67  
 Ex tb IIIC T6 - T4 °C Db IP67  
 -60 °C ≤ Ta ≤ 40 °C for T6  
 -60 °C ≤ Ta ≤ 55 °C for T5  
 -60 °C ≤ Ta ≤ 70 °C for T4

DIMENSION

SOLENOID TYPE : 58, 58-LT

SIZE	A	B	ØD
I	42	116	14
III	51	124	14

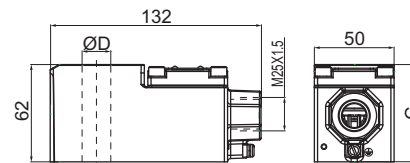
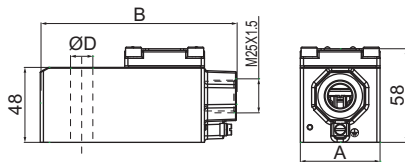

SIZE	C	ØD
II	58	18
IV	58	14

CABLE ENTRY M20X1.5, 1/2" NPT(F) (With Adopter)

SIZE	A	B	ØD
I	42	122	14
III	51	130	14

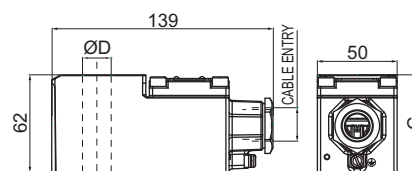
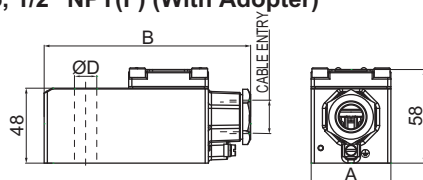

SIZE	C	ØD
II	58	18
IV	58	14

**CIRCUIT DIAGRAM**

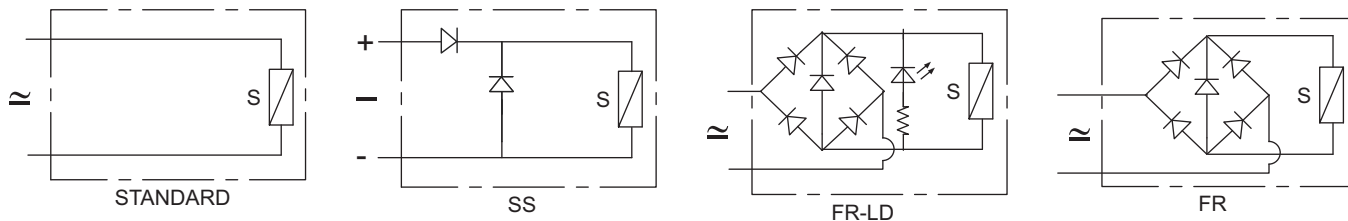

**FEATURES**

- Designed for extreme environmental condition
- Large terminals for easy connections
- Constructed for lowest temperature rise thus longer life
- 'O' Energiser for higher magnetic linkage
- Wider voltage variation
- Bottom Cable entry to avoid rain or process fluid entering into the termination area.
- For ease of operation and maintenance LED can be provided to confirm availability of voltage to the Solenoid terminals
- Dual gasket



**SPECIFICATION**

<b>Size</b>	II - 18 mm, III - 14 mm, IV - 14 mm
<b>Voltage</b>	6 V, 12 V, 24 V, 48 V, 110 V, 120 V, 220 V, 256 V
<b>Current</b>	50 Hz, 60 Hz, DC, 50 Hz/ 60 Hz/ DC
<b>Enclosure</b>	<b>Cable Entry</b> M25 X 1.5, Adopted to M20 X 1.5 or 1/2" NPT <b>Material</b> Aluminum Cast, Polyester Powder Coat, Colour Blue Stainless Steel Cast
<b>Options</b>	Surge Suppressor (SS), Fully Rectified (FR), LED (LD), Low Power (LW), Manual Reset (MR)
<b>Power</b>	Refer to table "Power" on page 431A
<b>Insulation Class</b>	Class H
<b>Weather Protection</b>	IP67, IP67 M Optionally IP68
<b>Approval</b>	INDIAN, ATEX, CU-TR, IECEx, CCOE, DGMS ①, SIL
<b>Voltage Variation</b>	Refer to Voltage Variation table on page 431B
<b>Duty Cycle</b>	100% (ED)
<b>Ambient Temperature</b>	Refer to Ambient temperature table on page 429C

① DGMS applied for

**WEIGHT IN kg**

Size	Al	SS
II	0.9	1.6
III	0.8	1.4
IV	0.9	1.6

**APPLICATION**



INDOOR



OUTDOOR



## POWER

Voltage	Solenoid		Power (VA)							
	Size	Core Dia	0.4②	1.8②	3.5	5	8	12	13	30
6	II	18					✓		▲	
	III	13	✓							
	III	14		✓	✓	✓	▲			
	IV	14		✓						
12	II	18					✓		▲	✓
	III	13	✓							
	III	14		✓	✓	✓	▲	▲		
	IV	14		✓						
24	II	18					✓		▲	✓
	III	13	✓							
	III	14		✓	✓	✓	▲	▲		
	IV	14		✓						
48	II	18							▲	✓
	III	13								
	III	14		✓	✓	✓	▲	▲		
	IV	14								
110-120	II	18					✓		▲	✓
	III	14				✓	▲	▲		
220-240	II	18					✓		▲	✓
	III	14				✓	▲	▲		
256②	II	18					✓		▲	✓
	III	14					▲			
	IV	14								

- ▲ Standard
- ✓ Optional Available
- ② Only for DC Current
- ③ Should be Opted for 3/2 & 5/2 pilot operated valves

## STANDARD POWER

Size	Current	Standard Power W, VA
I	AC	6, 12
	DC	8, 8
II	AC	13, 13
	DC	13, 13
III	AC	6, 12
	DC	8, 8

**EXPLOSION PROOF JUNCTION BOX SOLENOID (BCE) TYPE : 87**

Ex d

**SOLENOID ORDERING CODE**

III-24V-DC-87-CO-SS-LD-LWS-H-07

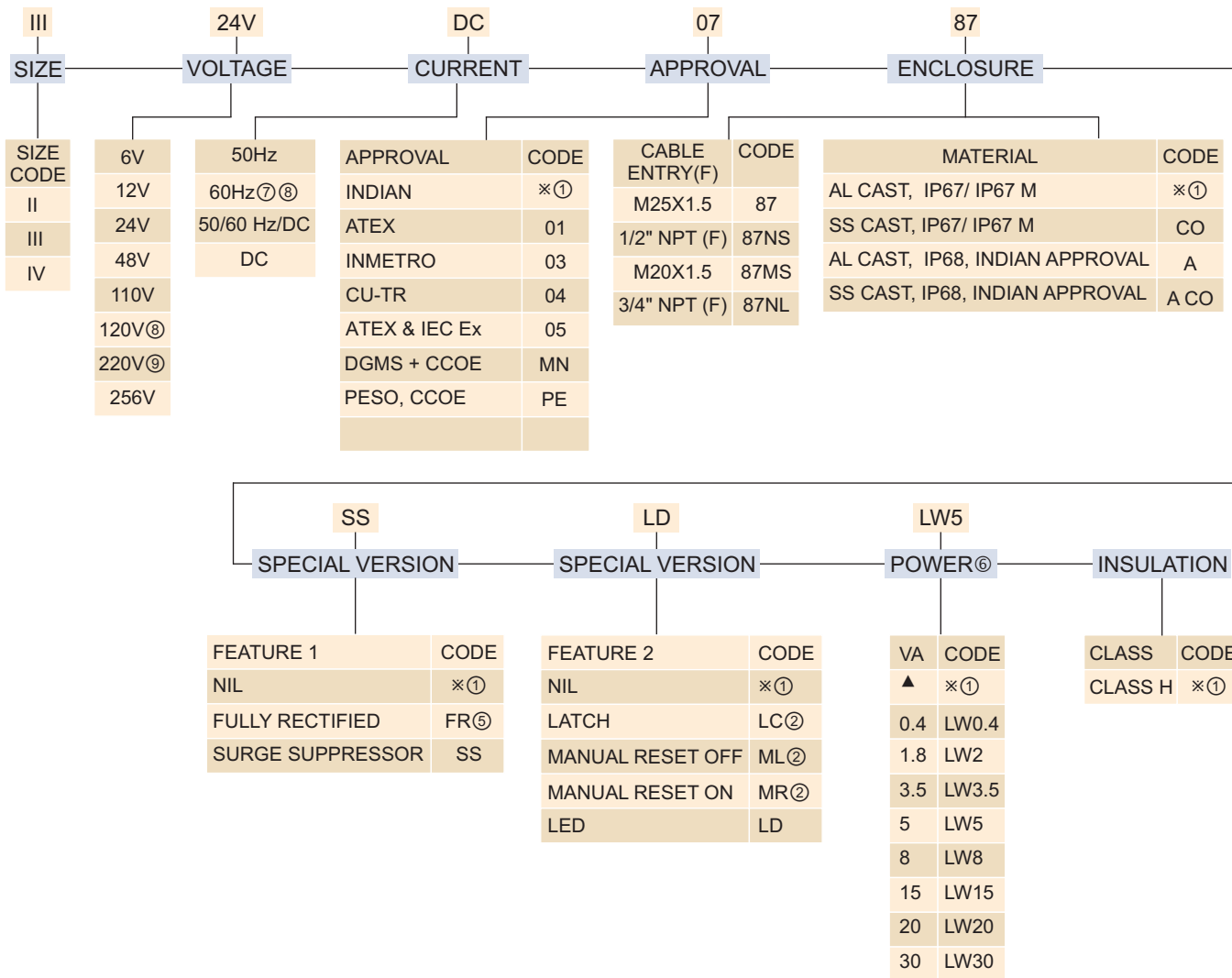

NOTE : ① Do not specify

② Voltage 24V, 110-120V, 220-240V current  
50-60 Hz/ DC power standard  
size II or III

⑤ Solenoid suitable for 50 Hz/ 60 Hz/ DC current, Select special version FR

⑥ Refer Power table on page 430A

⑧ 110-120V 50 Hz Solenoid can be used for 110V  
50 Hz, 120V 60 Hz

⑨ 220-240V Solenoid can be used for 220-240V 50 Hz,  
240V 60 Hz

**VOLTAGE VARIATION** (For Continuous Duty only)

Rated Voltage	Operating Voltage
6	4.8V to 7.2V
12	9.6V to 14.4V
24	19.2V to 28.8V
48	38.4V to 57.6V
110-120	88V to 132V
220-240	176V to 264V
256	192V to 280V



## MARKING

Temperature Class	Ambient
ATEX, IECEx	
II 2GD Ex d IIC T6 Gb Ex tb IIIC T80 °C Db IP67	- 60 °C < Ta < XX °C
II 2GD Ex d IIC T5 Gb Ex tb IIIC T95 °C Db IP67	- 60 °C < Ta < XX °C
II 2GD Ex d IIC T4 Gb Ex tb IIIC T130 °C Db IP67	- 60 °C < Ta < XXX °C
II 2GD Ex d IIC T3 Gb Ex tb IIIC T155 °C Db IP67	- 60 °C < Ta < XXX °C
INDIAN, DGMS, CCOE	
Ex d IIC T6 Gb Ex tb IIIC T80 °C Db IP67/ IP67 M/IP68	- 60 °C < Ta < XX °C
Ex d IIC T5 Gb Ex tb IIIC T95 °C Db IP67/ IP67 M/IP68	- 60 °C < Ta < XX °C
Ex d IIC T4 Gb Ex tb IIIC T130 °C Db IP67/ IP67 M/IP68	- 60 °C < Ta < XXX °C
Ex d IIC T3 Gb Ex tb IIIC T155 °C Db IP67/ IP67 M/IP68	- 60 °C < Ta < XXX °C
CU-TR	
Ex d IIC T6 IP67 Ex tb IIIC T80 °C Db IP67	- 60 °C < Ta < 70 °C
Ex d IIC T5 IP67 Ex tb IIIC T95 °C Db IP67	- 60 °C < Ta < 70 °C
Ex d IIC T4 IP67 Ex tb IIIC T130 °C Db IP67	- 60 °C < Ta < 100 °C
Ex d IIC T3 IP67 Ex tb IIIC T155 °C Db IP67	- 60 °C < Ta < 100 °C

## AMBIENT TEMPERATURE

SIZE	MAX. POWER	MAX. AMBIENT TEMPERATURE °C			
		T6	T5	T4	T3
III	5	65	80	100	
	8	60	75	100	
	15	50	65	100	
II	8	65	80	100	
	13	60	75	100	
	20		45	80	100
	30			60	70
IV	5	70	85	100	
	11	65	80	100	

- e.g. (1) Solenoid Size III, Power 8W  
ATEX approval II2 GD Ex d  
IIC T6 Gb Ex t IIC T80  
Db IP67  
-60 °C ≤ Ta ≤ 60 °C
- (2) Solenoid Size II, Power 30W  
as per INDIAN approval  
Ex d IIC T3 Gb  
Ex t IIC T155 Db IP67  
-60 °C ≤ Ta ≤ 70 °C



**EXPLOSION PROOF JUNCTION BOX SOLENOID (BCE) TYPE : 87** Ex d

**APPROVAL**

Approval	certifying Agencies	reference Number
INDIAN	KLPL	
BIS		7229976
CCOE/ PESO		
DGMS		
ATEX	DNV	DNV 12 ATEX 112883X
IECEX	DNV	IECEX, DNV 13.0006X
CU-TR		RU C-IN. ГБ08.B.01100

**DIMENSION SOLENOID TYPE : 87**

**CABLE ENTRY M25X1.5**

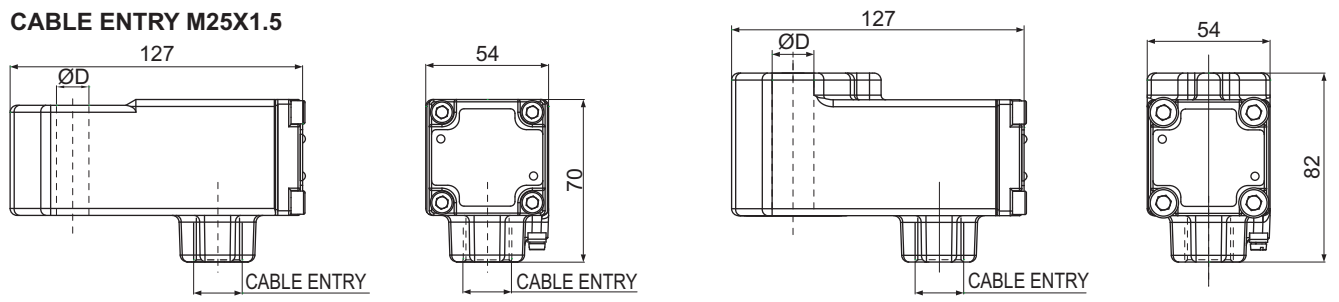

	ØD
III	13
III	14

	ØD
II	18
IV	14

**CABLE ENTRY M20X1.5, 1/2" NPT(F) (With Adopter)**

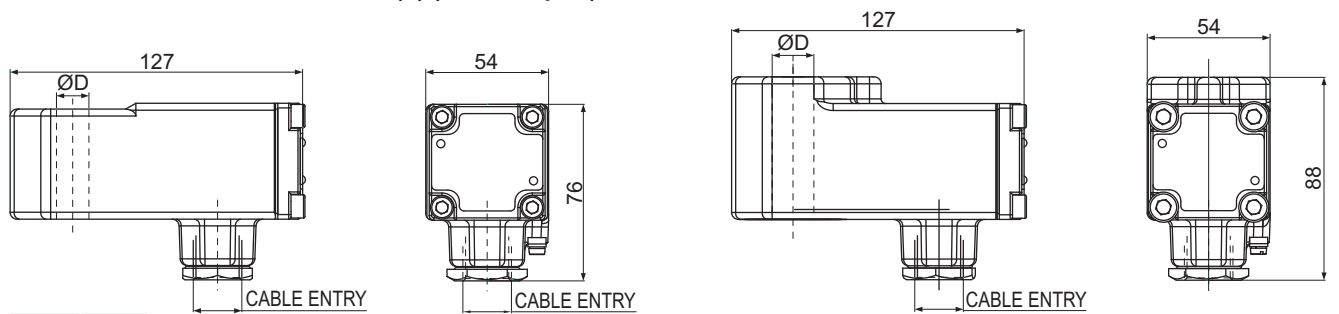

	ØD
III	13
III	14

	ØD
II	18
IV	14

**OBSELETE PRODUCTS AND ITS INTERCHANGEABILITY**

<p>Replace Solenoid code 87NS or 87MS along with Guide and Plunger assembly</p>	<p>Replace Solenoid code 87 or 87MS along with Guide and Plunger assembly</p>	<p>Solenoid code 39 replace with Solenoid code 87MS</p>		



**BARRIER SELECTION****LEGAL CRITERIA**

To meet requirement of installing Valves with Intrinsically safe Solenoid in the hazardous location of zone 0, zone 1, or zone 2, Power to the Intrinsically Safe Solenoid has to be supplied through certified Barrier Zener Diode, Solenoid Driver, Remote I/O (Power Source).

For meeting safety, it is essential to select and match entity parameter of Barrier (Power Source) as well as Field Device (Solenoid Valve) being installed in the hazardous environment.  $U_o$ ,  $I_o$ ,  $P_o$ ,  $C_o$ ,  $L_o$  are the Entity Parameters of the Power Source

$U_i$ ,  $I_i$ ,  $P_i$ ,  $C_i$ ,  $L_i$  are the Entity Parameters of the Field Device  $U_i$  (Voltage),  $I_i$  (Current),  $P_i$  (Power), of the solenoid (Field Device) should be more than  $U_o$  (Voltage),  $I_o$  (Current),  $P_o$  (Power), of the Power Source. i.e. ( $U_i \geq U_o$ ,  $I_i \geq I_o$ ,  $P_i \geq P_o$ )

$C_i$  (Capacitance),  $L_i$  (Inductance) of the field device and  $C_c$  (Capacitance),  $L_c$  (Inductance) of the Cable should be less than  $C_o$  (Capacitance),  $L_o$  (Inductance) of the Power Source  
i.e. ( $C_i + C_c \leq C_o$   $L_i + L_c \leq L_o$ )

**FUNCTIONAL CRITERIA****Barrier Data**

Output Volt @ Zero Current ( $V_{B0}$ ) : \_\_\_\_\_ Volt  
Output Volt @ Maximum Current ( $V_{BM}$ ) : \_\_\_\_\_ Volt  
Maximum Output Current ( $I_B$ ) : \_\_\_\_\_ mA

**Solenoid Data**

Minimum Operating Volt ( $V_C$ ) : \_\_\_\_\_ Volt  
Minimum Operating Current ( $I_C$ ) : \_\_\_\_\_ mA

**Permissible Cable Length (CL )****Resistance Based**

Resistance Based

Maximum Allowable Cable Resistance ( $R_C$ ) Ohm

$$R_C = [V_{B0} - ((V_{B0} - V_{BM}) * I_C / I_B)] * 1000 / I_C$$

Allowable Maximum Cable Length ( $CL_R$ ) should have Resistance  $\leq R_C$

**Capacitance Based**

Allowable Capacitance of the Barrier ( $C_o$ )

Cable Capacitance ( $C_c$ )

Coil Capacitance ( $C_i$ ) :  $C_c = 0$  (for ROTEX IS Solenoid)

$$C_o \geq C_c + C_i$$

Allowable Maximum Cable Length ( $CL_C$ ) should have Capacitance  $\leq C_o$

**Inductance Based**

Allowable Inductance of the Barrier ( $L_B$ )

Cable Inductance ( $L_c$ )

Solenoid Inductance ( $L_s$ ) :  $L_s = 0$  (for ROTEX IS Solenoid)

$$L_o \geq L_c + L_i$$

Allowable Maximum Cable Length ( $CL_L$ ) should have Inductance  $\leq L_o$

CL should be minimum of  $CL_R$ ,  $CL_C$ ,  $CL_L$

**CL should be minimum of  $CL_R$ ,  $CL_C$ ,  $CL_L$**



**CIRCUIT DIAGRAM**

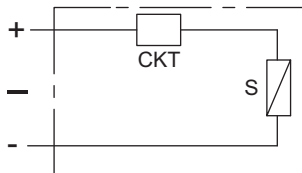

Type : 63, 64



**FEATURES**

- Designed for extreme environmental conditions
- Large terminals for easy connections
- Bottom Cable entry to avoid rain or process fluids entering into the termination area
- Can be adopted for any valve with core tube 14mm



Type : 62, 66

**SPECIFICATION**

<b>Size</b>	III, IV	
<b>Voltage</b>	24 V	
<b>Current</b>	DC	
<b>Enclosure</b>	<b>Cable Entry</b>	M25 X 1.5, Adopted to M20 X 1.5 or 1/2" NPT
	<b>Material</b>	Aluminum Cast, Polyester Powder Coat, Colour Blue Stainless Steel Cast
<b>Options</b>	LED (LD)	
<b>Power</b>	Refer entity & minimum operating parameter on page 432A	
<b>Insulation Class</b>	Class H	
<b>Weather Protection</b>	IP67	
<b>Approval</b>	INDIAN, ATEX, CU-TR, IECEx, CCOE, DGMS ①	
<b>Duty Cycle</b>	100% (ED)	
<b>Ambient Temperature</b>	Refer to marking on page 432C	

① DGMS applied for

**WEIGHT IN kg**

Type	Al	SS
II	0.9	1.6
III	0.8	1.4
IV	0.9	1.6

**APPLICATION**



## MINIMUM OPERATING PARAMETER

Operating Parameter	IS Coil with circuit (Size-III) Coil Type : 66	IS Coil with circuit (Size-IV) Coil Type : 62	IS Coil with cut & LED Type : 66 LD	IS Coil with circuit Type : 62 LD
Minimum Voltage	11 Volt	14 Volt	11 Volt	15 Volt
Minimum Current	20mA	25mA	22 mA	27 mA
Minimum Power	0.22 Watt	0.35 Watt	0.24 Watt	0.40 Watt
LED	No	No	Yes	Yes
Valve Type	2XXXX, 3XXXX, 4XXXX 5XXXX, 3XXX, VB (Except 30308, 30334, 30138 & 30318 etc.)	30318LW1.8 & P3017	2XXXX, 3XXXX, 4XXXX 5XXXX, 3XXX, VB (Except 30308, 30334, 30138 & 30318 etc.)	30318LW1.8 & P3017

## ENTITY PARAMETER

Entity Parameter	
Ui	32V DC
li	230mA
Pi	2.3W
Ci	0
Li	0

## RESPONSE ON TIME

Voltage	10	12	14	18	22	26	30	32
Current mA	17	21	25	33	41	49	57	61
Delay Time in Mili Sec.	2500	1200	1000	100	60	50	50	50

## RESPONSE OFF TIME

10mS to 20mS

**INTRINSICALLY SAFE SOLENOID WITH CIRCUIT TYPE : 62, 66, 63, 64**

**Ex ia**

**SOLENOID ORDERING CODE**

**III-24V-DC-66-CO-MS-07**

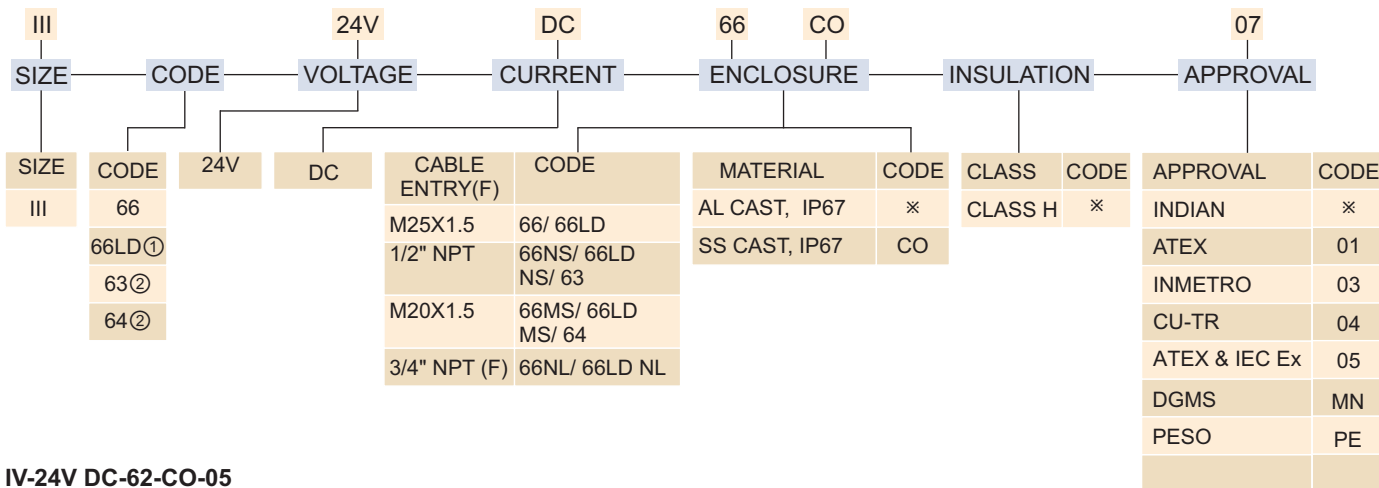

**IV-24V DC-62-CO-05**

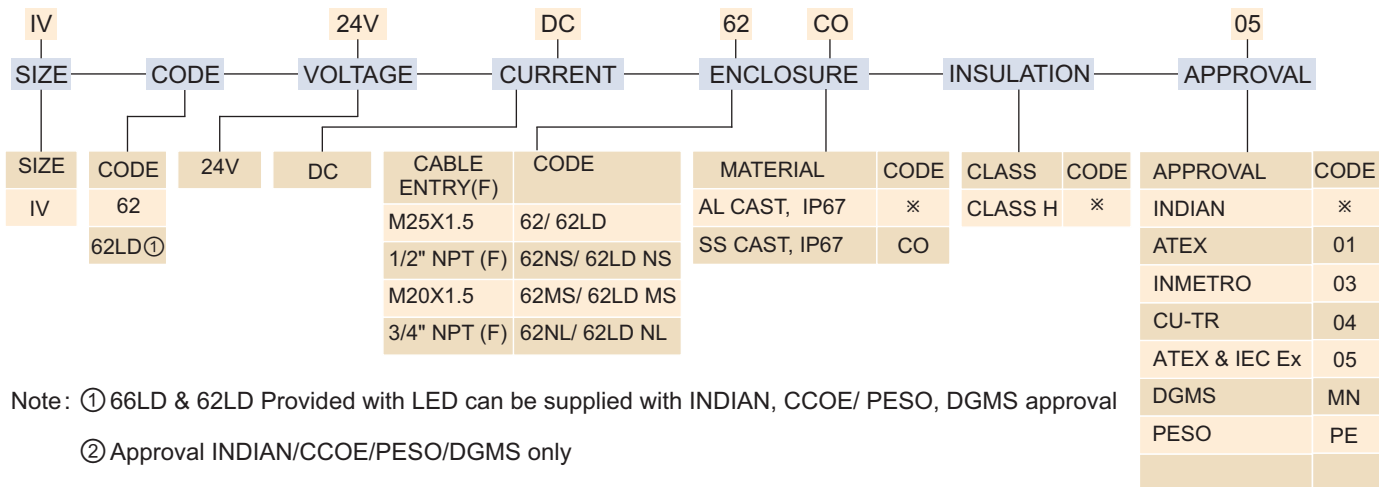

Note: ① 66LD & 62LD Provided with LED can be supplied with INDIAN, CCOE/ PESO, DGMS approval

② Approval INDIAN/CCOE/PESO/DGMS only

**APPROVAL**

**Solenoid Type : 62, 66**

Approval	Certifying Agencies	Reference Number
INDIAN	KLPL	KLPL/Ex/13-022X
	NA	
DGMS	DGMS	232 of 2011
BIS		7560881
CCOE/ PESO	PESO	
EUROPEAN/ ATEX	Baseefa	Baseefa 12 ATEX 0243X
CU-TR		RU C- IN.ГБ08.B.01100
INMETRO		
IECEX	Baseefa	IECEX BAS 12.0128XIssu1

**MARKING**

ATEX & IECEx	AMBIENT TEMPERATURE
Ex I M I Ex ia II Ma	- 60 °C ≤ Ta ≤ +75 °C
Ex II 1G Ex ia IIC T5 Ga	- 60 °C ≤ Ta ≤ +75 °C
Ex II 1G Ex ia IIC T6 Ga	- 60 °C ≤ Ta ≤ +60 °C
Ex II 1D Ex ia IIIC T200 125 °C IP67Da	- 60 °C ≤ Ta ≤ +75 °C
INDIAN, PESO/ CCOE, DGMS (FOR COIL TYPE 63)	
Ex ia I/IIC T5, IP67	- 40 °C ≤ Ta ≤ +75 °C
Ex ia I/IIC T6, IP67	- 40 °C ≤ Ta ≤ +60 °C
CU-TR	
Ex ia I or	- 60 °C ≤ Ta ≤ 75 °C
Ex ia IIC T5 Ga	- 60 °C ≤ Ta ≤ 75 °C
Ex ia IIC T6 Ga	- 60 °C ≤ Ta ≤ 60 °C
Ex ia IIIC T <sub>200</sub> 125 °C Da	

**Solenoid Type : 63, 64**

Approval	Certifying Agencies	Reference Number
INDIAN	CMRI./ CIMFR	CIMFR/TC/P/H702 & CMRI/TC/SR/H920
	KLPL (Revalidated)	KLPL/Ex/13-022X
BIS		7560881
CCOE/ PESO		
DGMS	DGMS	231 of 2011

\* Only for SS cast enclosure



**INTRINSICALLY SAFE SOLENOID WITH CIRCUIT TYPE : 62, 66, 63, 64**

**Ex ia**

**DIMENSION**

**SOLENOID TYPE : 62, 66**

**CABLE ENTRY M25X1.5**

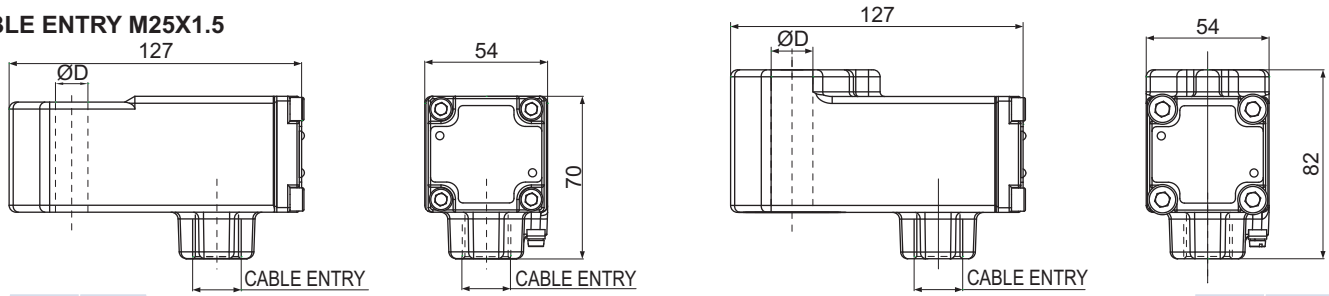

	ØD
III	13
III	14

	ØD
II	18
IV	14

**CABLE ENTRY M20X1.5, 1/2" NPT (With Adopter)**

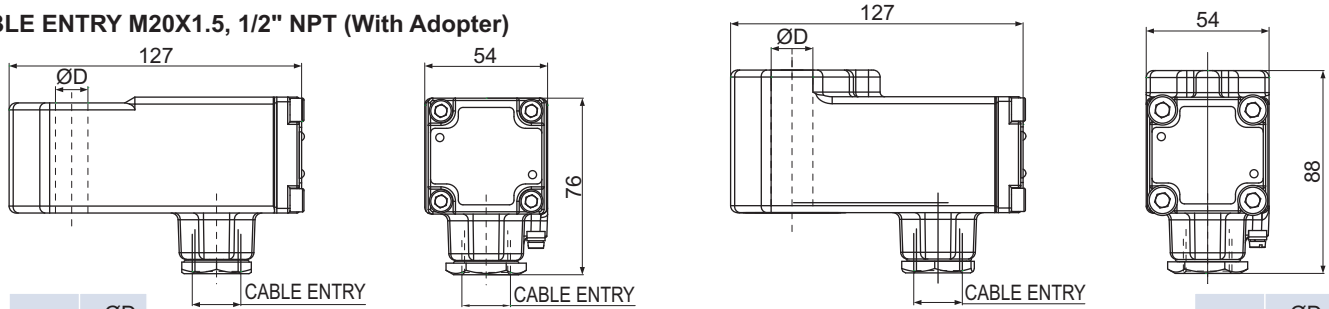

	ØD
III	13
III	14

	ØD
II	18
IV	14

**SOLENOID TYPE : 63, 64**

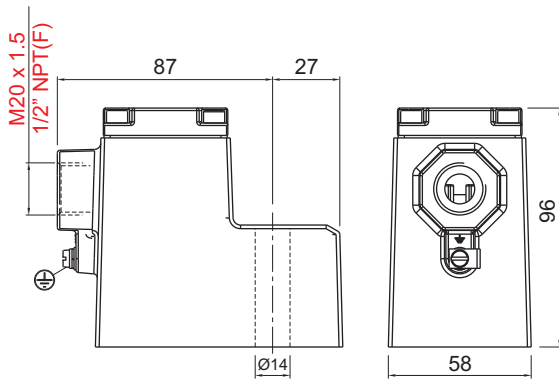

SIZE	B	ØC
III	56	13
I		

**OBSELETE PRODUCTS AND ITS INTERCHANGEABILITY**

<p>Replace with Solenoid type 66 along with Guide and pressure assembly</p>	<p>Type : 63, 64, 63-01, 64-01</p>  <p>Replace with Solenoid Type 66</p>			
---	---	--	--	--

CIRCUIT DIAGRAM

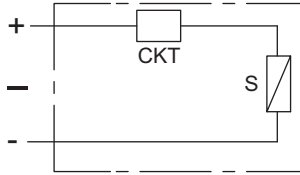

FEATURES

- Designed for extreme environmental conditions
- 'O' Energiser for higher magnetic linkage
- DIN Plug provided



SPECIFICATION

<b>Size</b>	III - 13 mm	
<b>Voltage</b>	24 V	
<b>Current</b>	DC	
<b>Enclosure</b>	<b>Cable Entry</b>	Pg-9, DINPLUG AS PER DIN 43650A
	<b>Material</b>	Steel chrome plated
<b>Insulation Class</b>	Class H	
<b>Weather Protection</b>	IP67	
<b>Approval</b>	INDIAN, CCOE, DGMS <sup>①</sup> , GOST R	
<b>Duty Cycle</b>	100% (ED)	

① DGMS applied for

ENTITY PARAMETER

Entity Parameter	
Ui	32V DC
Ii	230mA
Pi	2.3W
Ci	0
Li	0

WEIGHT IN kg

Type	Al/ kg	SS
III	0.37	

APPLICATION



INDOOR



OUTDOOR

# LOW POWER INTRINSICALLY SAFE SOLENOID TYPE : 65 CR

Ex ia

## SOLENOID ORDERING CODE III-24V-DC-65CR

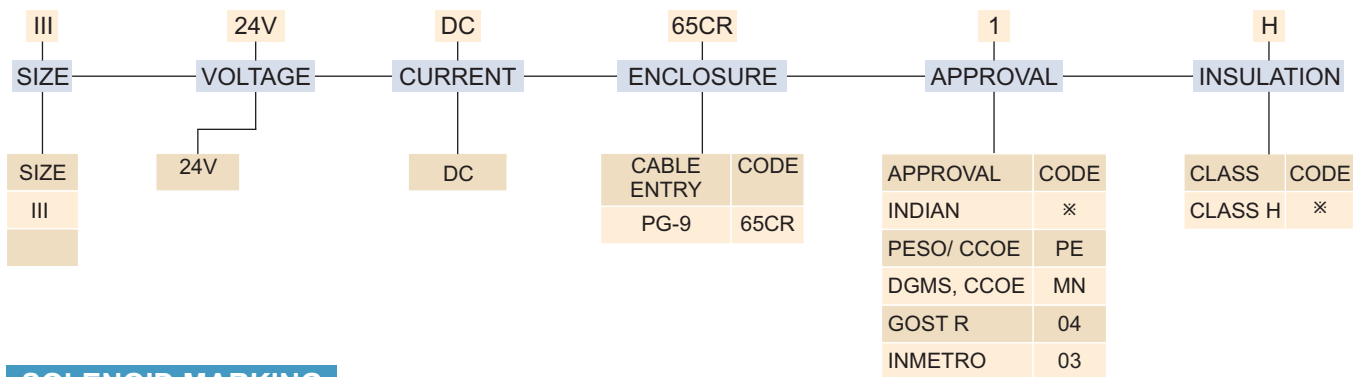

## SOLENOID MARKING

Aluminium, Cast	Satinless Steel, Cast
INDIAN	
Ex ia I/ IIC T5, IP67	- 40 °C ≤ Ta ≤ 75 °C
IEx ia I/ IIC T6 IP67	- 40 °C ≤ Ta ≤ 60 °C

## MARKING

GOST R	
1Ex (ia) dIIC T6	- 40 °C to +70 °C

## MINIMUM OPERATING PARAMETER

Valve Code I3XXX & I5XXX	Max. Pressure 11bar
Minimum Voltage	14V
Minimum Current	25mA
Minimum Power	0.35W
Valve Code I3XXXEP & I5XXXEP	Max. Pressure 14bar
Response ON	50 ms
Response OFF	30 ms

## APPROVAL

Approval	Certifying Agencies	Reference Number
INDIAN	KLPL	KLPL/Ex/13-022X
BIS		7560881
CCOE/ PESO*		
DGMS		231 of 2011
GOST R	CIS	POCC IN.ГБ06.B01292
INMETRO	CEPEL	CEPEL08.1718

## DIMENSION

## SOLENOID TYPE : 65 CR

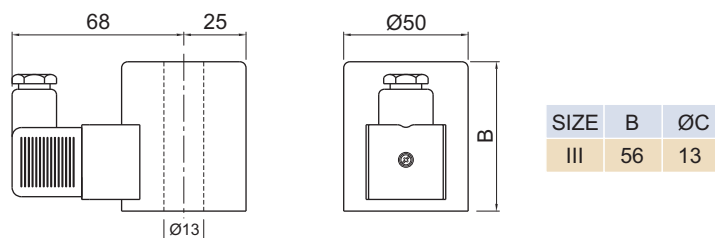

**LOW POWER INTRINSICALLY SAFE SOLENOID TYPE : 67, 71**

Ex ia

**CIRCUIT DIAGRAM**

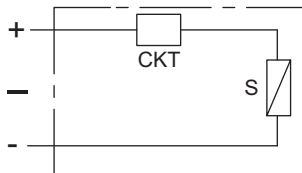

TYPE 71



TYPE 67

**FEATURES**

- Designed for extreme environmental conditions
- Large terminals for easy connections
- Constructed for lowest temperature rise thus longer life
- 'O' Energiser for higher magnetic linkage
- Wider voltage variation



**SPECIFICATION**

<b>Size</b>	III - 13 mm, IV - 14 mm
<b>Voltage</b>	24 V
<b>Current</b>	DC
<b>Enclosure</b>	<b>Horizontal Cable Entry</b> Type 67 <b>Bottom Cable Entry</b> Type 71
<b>Cable Entry</b>	M25 X 1.5, Adopted to M20 X 1.5 or 1/2" NPT
<b>Approval</b>	INDIAN, ATEX, CU-TR, CCOE, DGMS ①, IECEx
<b>Ambient Temperature</b>	-60 °C to 70 °C

**WEIGHT IN kg**

**TYPE 67**

Size	Al/ kg	SS/ kg
III	0.6	1.4
IV	0.8	1.6

**TYPE 71**

Size	Al/ kg	SS/ kg
III	0.8	1.4
IV	0.9	1.6

**APPLICATION**



INDOOR



OUTDOOR



**LOW POWER INTRINSICALLY SAFE SOLENOID TYPE : 67, 71**

**Ex ia**

**SOLENOID ORDERING CODE III-24V-DC-67**

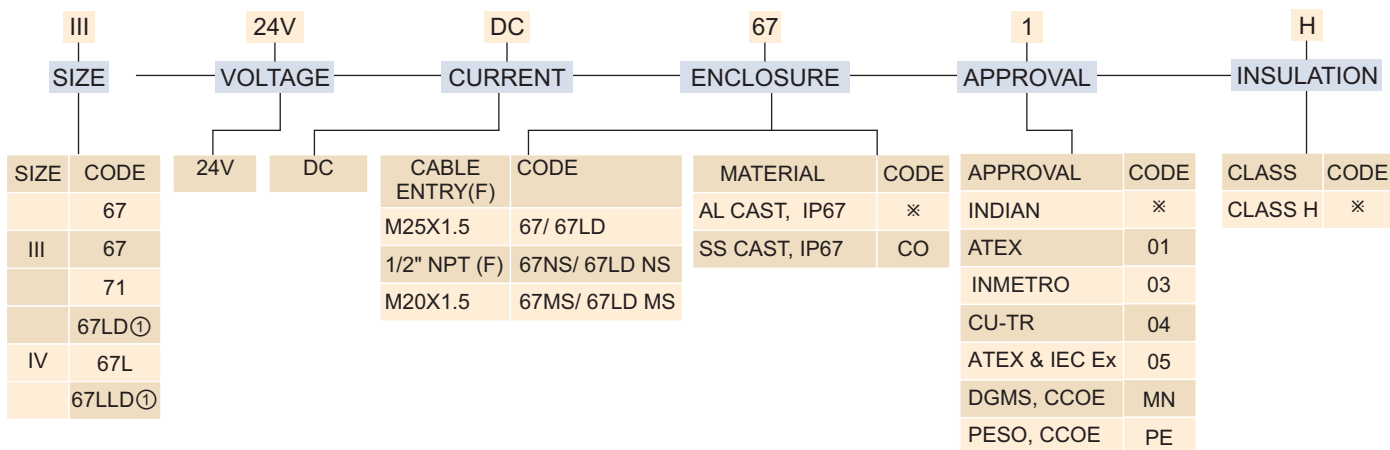

**IV-24V-DC-71-05**

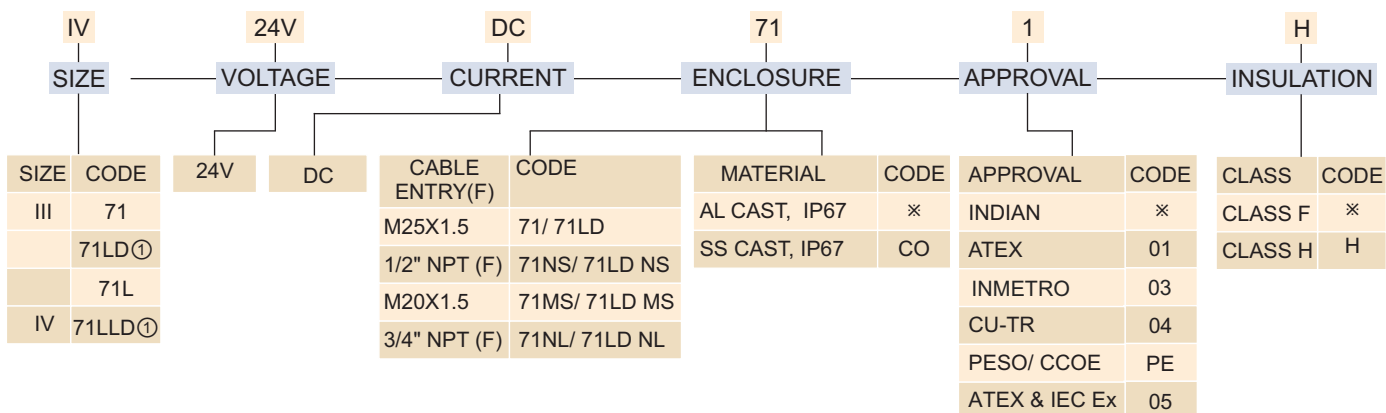

Note : ① 67LD, 71LD, 67LLD, 71LLD Supplied with LED and can be supplied with INDIAN, CCOE/PESO, DGMS approval

**APPROVAL Type : 67**

Approval	Certifying Agencies	Reference Number
INDIAN	CMRI CIMFR	CMRI/TC/SR/H-834
	KLPL ( )Revalidated	KLPL/Ex/13-022X
BIS		7560881
CCOE/ PESO		
DGMS	DGMS	231 of 2011
INMETRO	CEPL	CEPL 08.1718
CU-TR		RU C- IN.Г508.B.01100
ATEX	Baseefa	Baseefa12ATEX0243X
IECEX	Baseefa	IECEX BAS 12.0128X

**Type : 71**

Approval	Certifying Agencies	Reference Number
INDIAN	KLPL Revalidated	KLPL/Ex/13-022X
BIS		7560881
CCOE/ PESO*		
DGMS*		
CU-TR		RU C- IN.Г508.B.01100
ATEX	Baseefa	Baseefa12ATEX0243X
IECEX	Baseefa	IECEX BAS 12.0128X





## ENTITY PARAMETER

Entity Parameter	
Ui	32V
Ii	230mA
Pi	2.3W
Ci	0
Li	0

## MINIMUM OPERATING PARAMETER

Operating Parameter	VALVE TYPE I3XXX & I5XXX, Pressure Maximum 11 kg/ cm <sup>2</sup>				VALVE TYPE I3XXXEP & I5XXXEP Pressure Maximum 8 kg/ cm <sup>2</sup>			
	Solenoid Code				Solenoid Code			
	67	67LD	67L	67LLD	67	67LD	67L	67LLD
Minimum Voltage	14V	14V			11V	11V		
Minimum Current	25mA	28mA	CONTACT ROTEX		19mA	22mA	CONTACT ROTEX	
Minimum Power	0.35W	0.39W			0.21W	0.24W		
LED	NO	YES	NO	YES	NO	YES	NO	YES
Response ON	60 ms							
Response OFF	40 ms							

Operating Parameter	VALVE TYPE I3XXX & I5XXX, Pressure Maximum 11 kg/ cm <sup>2</sup>				VALVE TYPE I3XXXEP & I5XXXEP Pressure Maximum 8 kg/ cm <sup>2</sup>			
	Solenoid Code				Solenoid Code			
	71	71LD	71L	71LLD	71	71LD	71L	71LLD
Minimum Voltage	14V	14V			11V	11V		
Minimum Current	25mA	28mA	CONTACT ROTEX		19mA	22mA	CONTACT ROTEX	
Minimum Power	0.35W	0.39W			0.21W	0.24W		
LED	NO	YES	NO	YES	NO	YES	NO	YES
Response ON	60 ms							
Response OFF	40 ms							

## MARKING Solenoid Type : 67, 67LD

ATEX & IECEx		Ambient Temperature
I M1 Ex ia II Ma*		- 60 °C ≤ Ta ≤ 75 °C
II 1G Ex ia IIC T5 Ga		- 60 °C ≤ Ta ≤ 75 °C
II 1G Ex ia IIC T6 Ga		- 60 °C ≤ Ta ≤ 60 °C
II 1D Ex ia IIIC T200 125 °C Da IP67		- 60 °C ≤ Ta ≤ 75 °C
INDIAN, DGMS,CCOE/ PESO		
Ex ia IIC T5 Ga		- 60 °C ≤ Ta ≤ 75 °C
Ex ia IIC T6 Ga		- 60 °C ≤ Ta ≤ 60 °C
CU-TR		
Exia I		- 60 °C to +75 °C
Ex ia IIC T5		- 60 °C to +75 °C
Ex ia IIC T6		- 60 °C to +75 °C
Ex ia IIIC T200 125 °C Da IP67		- 60 °C ≤ Ta ≤ 75 °C

\* Only for SS cast enclosure

## Solenoid Type : 71, 71LD

ATEX & IECEx		Ambient Temperature
I M1 Ex ia II Ma*		- 60 °C ≤ Ta ≤ 75 °C
II 1G Ex ia IIC T5 Ga		- 60 °C ≤ Ta ≤ 75 °C
II 1G Ex ia IIC T6 Ga		- 60 °C ≤ Ta ≤ 60 °C
II 1D Ex ia IIIC T200 125 °C Da IP67		- 60 °C ≤ Ta ≤ 75 °C
INDIAN, DGMS,CCOE/ PESO		
Ex ia IIC T5 Ga		- 60 °C ≤ Ta ≤ 75 °C
Ex ia IIC T6 Ga		- 60 °C ≤ Ta ≤ 60 °C
CU-TR		
Exia I		- 60 °C to +75 °C
Ex ia IIC T5		- 60 °C to +75 °C
Ex ia IIC T6		- 60 °C to +75 °C
Ex ia IIIC T200 125 °C Da IP67		- 60 °C ≤ Ta ≤ 75 °C

\* Only for SS cast enclosure



**LOW POWER INTRINSICALLY SAFE SOLENOID TYPE : 67, 71**

**Ex ia**

**DIMENSION SOLENOID TYPE : 71**

**CABLE ENTRY M25X1.5**

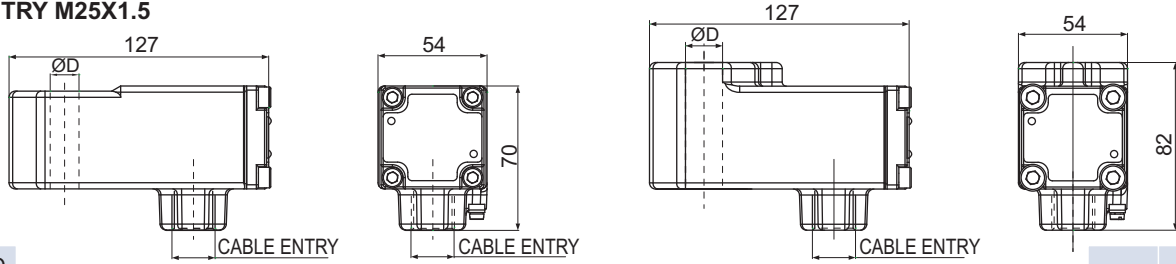

	ØD
III	13
III	14

	ØD
II	18
IV	14

**CABLE ENTRY M20X1.5, 1/2" NPT (With Adopter)**

**SOLENOID TYPE : 71**

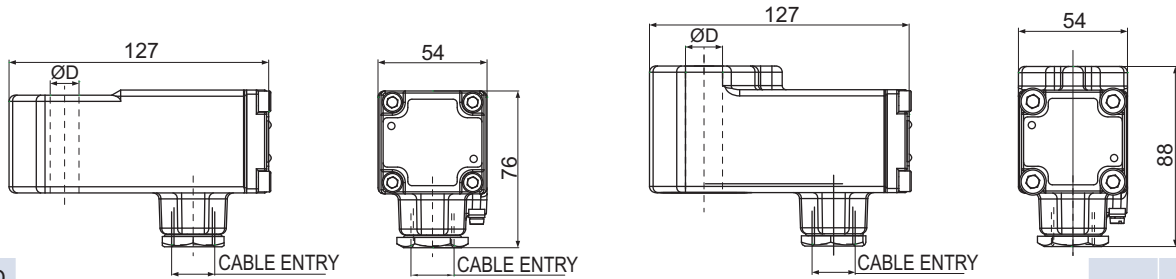

	ØD
III	13
III	14

	ØD
II	18
IV	14

**CABLE ENTRY M20X1.5**

**SOLENOID TYPE : 67**

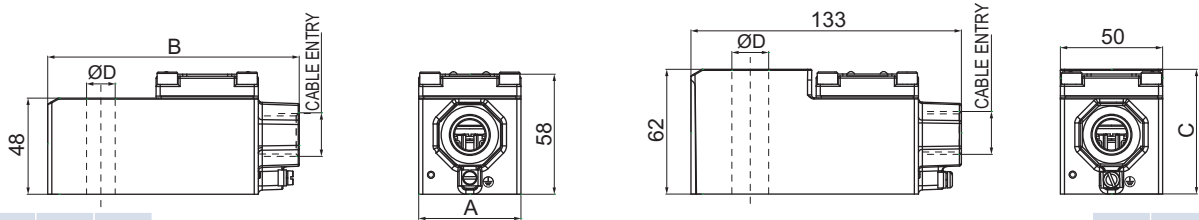

SIZE	A	B	ØD
I	42	116	14
III	50	124	14
III	50	124	13

SIZE	C	ØD
II	61	18
IV	51	14

**CABLE ENTRY M20X1.5 & 1/2" NPT (With Adopter)**

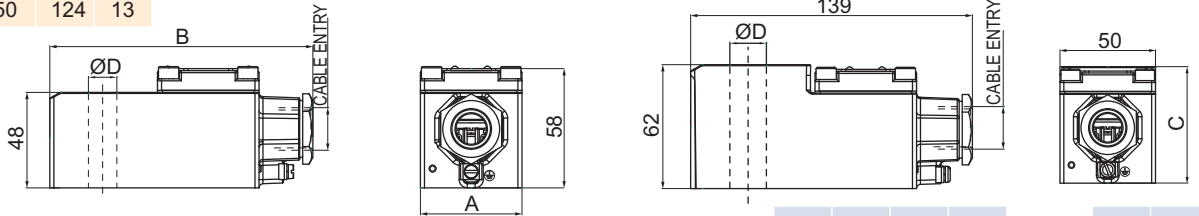

SIZE	A	B	ØE
I	42	122	14
III	50	130	14
III	50	130	13

SIZE	C	ØD
II	61	18
IV	51	14

**OBSELETE PRODUCTS AND ITS INTERCHANGEABILITY**

	 <p>Coil Type 72 &amp; 73 is been Replaced by 67 &amp; 71</p>		
--	--	--	--