

2/2 DIRECT ACTING, HIGH ORIFICE NORMALLY CLOSED SOLENOID VALVE

TYPE	PRESSURE

TYPE	PRESSURE

TYPE	PRESSURE
20172V02	0 - 10 bar
20172V03-40	0 - 10 bar

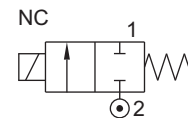

FEATURES

- Bubble tight shut off
- Vibration resistance up to 9g
- Suitable for high speed cycling
- Speed up to 100 cycles/ min.
- Life >2 million cycles
- **Mount Solenoid upward Vertical**

WETTED PARTS

Code		B12	B13
Body		CF8M	CF8
Diaphragm	Viton, NBR, EPDM		
Guide Assembly	SS 304		
Shadow-Ring	Copper		
Plunger, Insert	SS 430		
Spring	SS 302		
Seat, Seals	NBR, Viton, EPDM		
Fasteners	SS 304		

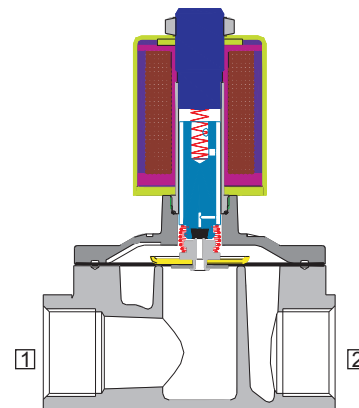

AMBIENT AND FLUID TEMPERATURE

-30 °C to 75 °C

SPECIAL VERSION AND SUFFIX

Suffix : (Valve) OX, AM
Special version : (Solenoid) CO, FR, SS

MEDIA

Air, Inert gases, Water, Free flowing liquid, Oil, Diesel, Kerosene, LPG, CNG

APPLICATION

Drain shut off

PORT CONNECTION

ACTION	INLET	OUTLET
NC	2	1

SPARES

(Refer page 25 for ordering code)

SPARE KIT	CODE
Diaphragm Kit : Diaphragm Set	100
Seal Kit : Oring Set, Diaphragm Set, Plunger Assembly	98
Repair Kit : Oring Set, Diaphragm Set, Plunger Assembly, Fastener, Springs, Guide Assembly	99
Solenoid Kit : Solenoid, Gasket and Nut	34

APPROVAL

(★ applied for)

Approval	TYPE 4X, 6P	IP67	Ex d IIC T4 or T5 or T6 IP66	Ex ia IIC T6 IP67	DGMS	CCOE
		✓	✓	✓	✓	✓
CE						
UL						
ERC						

Contact Rotex for any other ambient, fluid temperature, media and application



SPECIFICATION

PORT CONNECTION			PRE-SURE bar		ORIFICE (mm) FLOW FACTOR Kv (LPM OF WATER @ 1 bar ΔP)	VALVE TYPE	PILOT PRESSURE	BODY MATERIAL AND INTERNALS						SEALS					MANUAL OVERRIDE		SOLENOID ENCLOSURE			SUFFIX		POWER VA		CONSTRUCTION REFERENCE NUMBER
SIZE	BSP(F)	NPT(F)	MINIMUM	MAXIMUM				ALUMINIUM	SS 316/ CF8M	BRASS	SS 304/ CF8	NBR	Viton	EPDM	HYTREL	PTFE	NIL	STAYPUT CUM MOMENTARY	FLYING LEAD	PLUG IN, IP67	SQ. PLUG IN, IP67	TERMINAL BOX IP67	EXPLOSION PROOF IIC, IP67	LARGE ENCLOSURE	SOLENOID SIZE	OXYGEN	AMONIA	

2/2 NORMALLY CLOSED

1/2"	4G	4R	0	10	12	50	20172V02	B12	B13	S0	S2			*				25	T			18	✓	✓	30	30	30	15
3/4"	6G	6R	0	10	20	95	20172V02	B12	B13	S0	S2			*				25	T			18	✓	✓	30	30	30	20
1"	8G	8R	0	10	25	160	20172V02	B12	B13	S0	S2			*				25	T			18	✓	✓	30	30	30	20
1 1/2"	12G	12R	0	10	40	350	20172V03	B12	B13	S0	S2			*				25	T			18	✓	✓	30	30	30	30
1/2"	4G	4R	0	5	12	50	GEFI GXECSU	B12	B13	S0	S2			*				25	T			18	✓	✓	15	15	15	15
3/4"	6G	6R	0	5	20	95	GEFI GXECSU	B12	B13	S0	S2			*				25	T			18	✓	✓	15	15	15	20
1"	8G	8R	0	5	25	160	GEFI GXECSU	B12	B13	S0	S2			*				25	T			18	✓	✓	15	15	15	20
1 1/2"	12G	12R	0	5	40	350	GEFI GXECSU	B12	B13	S0	S2			*				25	T			18	✓	✓	15	15	15	30
2"	16G	16R	0	5	50	560	GEFI GXECSU	B12	B13	S0	S2			*				25	T			18	✓	✓	15	15	15	30

SOLENOID 18

Cable Entry	T	Öc/ä	E	Öc/Ä/ä
M20 x 1.5	FJ	İTÜ	HU	İİTÜ
M25 x 1.5	Fİ	İİ		İİ İİŞV
1/2" NPT	Fİ	İİPÜ	Hİ	İİPÜ İİŞVÜ

* = Do not specify when opted for. Refer Page # 22 for Value of *
✓ = Options available

ORDERING CODE AND EXAMPLE VALVE + SOLENOID

TYPE - SUFFIX - ORIFICE - PORT CONNECTION - BODY AND INTERNALS - SEAL +
SIZE - VOLTAGE - CURRENT - SOLENOID ENCLOSURE - APPROVAL - INSULATION - SPECIAL VERSION
e.g. 20172V02-25-8G+24V-DC-25-LW30; 20172V02-12-4G-S2+230V-50Hz/60Hz-19-LW30

DIMENSIONS

All Dimensions are in mm

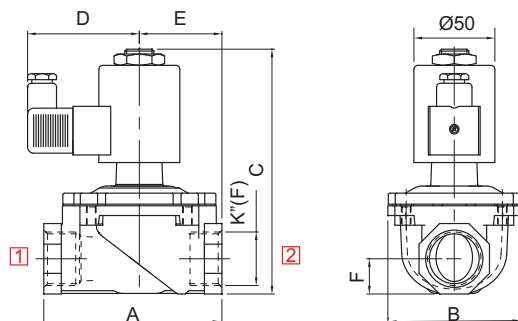

SQUARE PLUG IN SOLENOID TYPE 25

NW	K (PORT SIZE)	A	B	C	D	E	F	CONST. REF.
VALVE TYPE : 20172V02/20172V03/20172V02LP								
12	1/2", 3/8", 1/4"	65	50	124	66	29	15	29
20	3/4"	84	64	134	66	42	17	30
25	1"	110	93	148	66	51	25	31
40	1 1/2"	135	94	168	68	68	30	32A

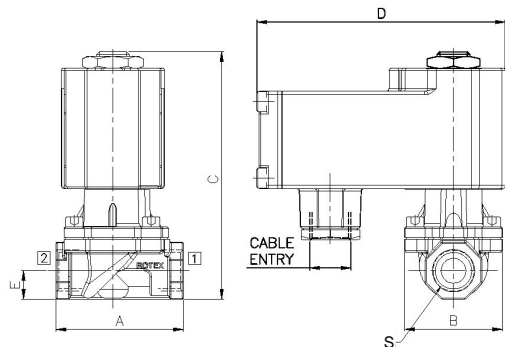

TERMINAL BOX/ Ex d LARGE ENCLOSURE, TYPE 16, 19, 37, 39, 58, 58LT, LC

NW	K (PORT SIZE)	A	B	C	D	E	F	CONST. REF.
VALVE TYPE : 20172V02/20172V03/20172V02LP								
12	1/2", 3/8", 1/4"	65	50	124	103	29	15	29
20	3/4"	84	64	134	103	42	17	30
25	1"	110	82	152	103	51	22	31
40	1 1/2"	135	94	168	103	65	30	
50	2"	165	140	188	103	75	38	32



Plug In Coil type 25 can be supplied only for 'DC' Voltages.

DIN PLUG IN SOLENOID TYPE : 22, 25

CIRCUIT DIAGRAM

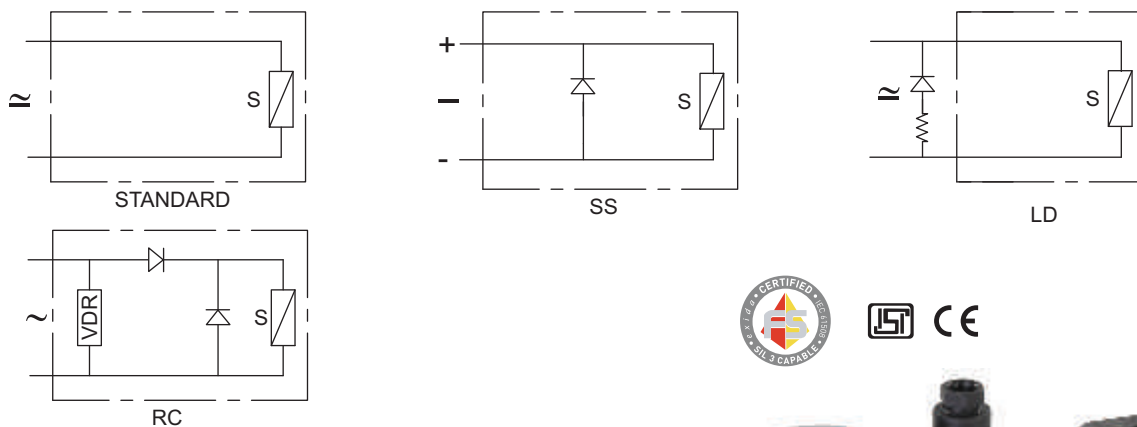

FEATURES

- Designed for extreme environmental condition
- Constructed for lowest temperature rise thus longer life
- 'O' Energiser for higher magnetic linkage
- Wider voltage variation
- DIN Plug supplied with Solenoid

SPECIFICATION

Size	I-14 mm, II-18 mm & III-14 mm, 13mm, IV-14mm
Voltage	6 V, 12 V, 24 V, 48 V, 110 V, 220 V
Current	50 Hz, 60 Hz, DC
Enclosure	Cable Entry Pg 9 : As per DIN 43650 Type A & Type B Material Moulded plastic, Steel Chrome plated
Options	Surge Suppressor (SS), LED (LD), Low Power (LW), Rectified (RC)
Power	Refer to table "Power" on page 425A
Insulation Class	Class F, Optionally Class H
Weather Protection	IP67, IP67 M
Approval	Indian, European, SIL
Voltage Variation	Refer to Voltage Variation Table (on page 425B)
Duty Cycle	100% (ED)
Ambient Temperature	Class F, Power ≤ 13W, -20 °C to 75 °C Class H, Power ≤ 13W, -20 °C to 100 °C, Power ≥ 13W, -20 °C to 75 °C

WEIGHT IN kg

Size	Moulded Plastic	Steel
I	0.2	0.250
II		0.450
III		0.370

APPLICATION



INDOOR



OUTDOOR

DIN PLUG IN SOLENOID TYPE : 22, 25

POWER

Voltage	Solenoid		Power (VA)						
	Size	Core Dia	0.4②	1.8②	3.5	8	12	13	30②
6	I	14							
	II	18				✓		▲	
	III	13	✓						
	III	14		✓	✓	▲			
	IV	14		✓					
12	I	14				▲	▲		
	II	18				✓		▲	✓
	III	13	✓						
	III	14		✓	✓	▲			
	IV	14		✓					
24	I	14		✓		▲	▲		
	II	18				✓		▲	✓
	III	13	✓						
	III	14		✓	✓	▲			
	IV	14		✓					
48	I	14				▲	▲		
	II	18						▲	✓
	III	14		✓	✓	▲			
110-120	I①	14					▲		
	II	18				✓		▲	✓
	III	14				▲			
220-240	I①	14					▲		
	II	18				✓		▲	✓
	III	14				▲			
256②	II	18				✓		▲	✓
	III	14				▲			

▲ Standard

✓ Optional Available

① Select Current 50 Hz or 60 Hz

② Select Current DC

STANDARD POWER

Size	Current	Standard Power W, VA
I	AC	6, 12
	DC	8, 8
II	AC	13, 13
	DC	13, 13
III	AC	6, 12
	DC	8, 8

DIN PLUG IN SOLENOID TYPE : 22, 25

SOLENOID ORDERING CODE

III-24V-DC-22-SS-LD-LW5-H

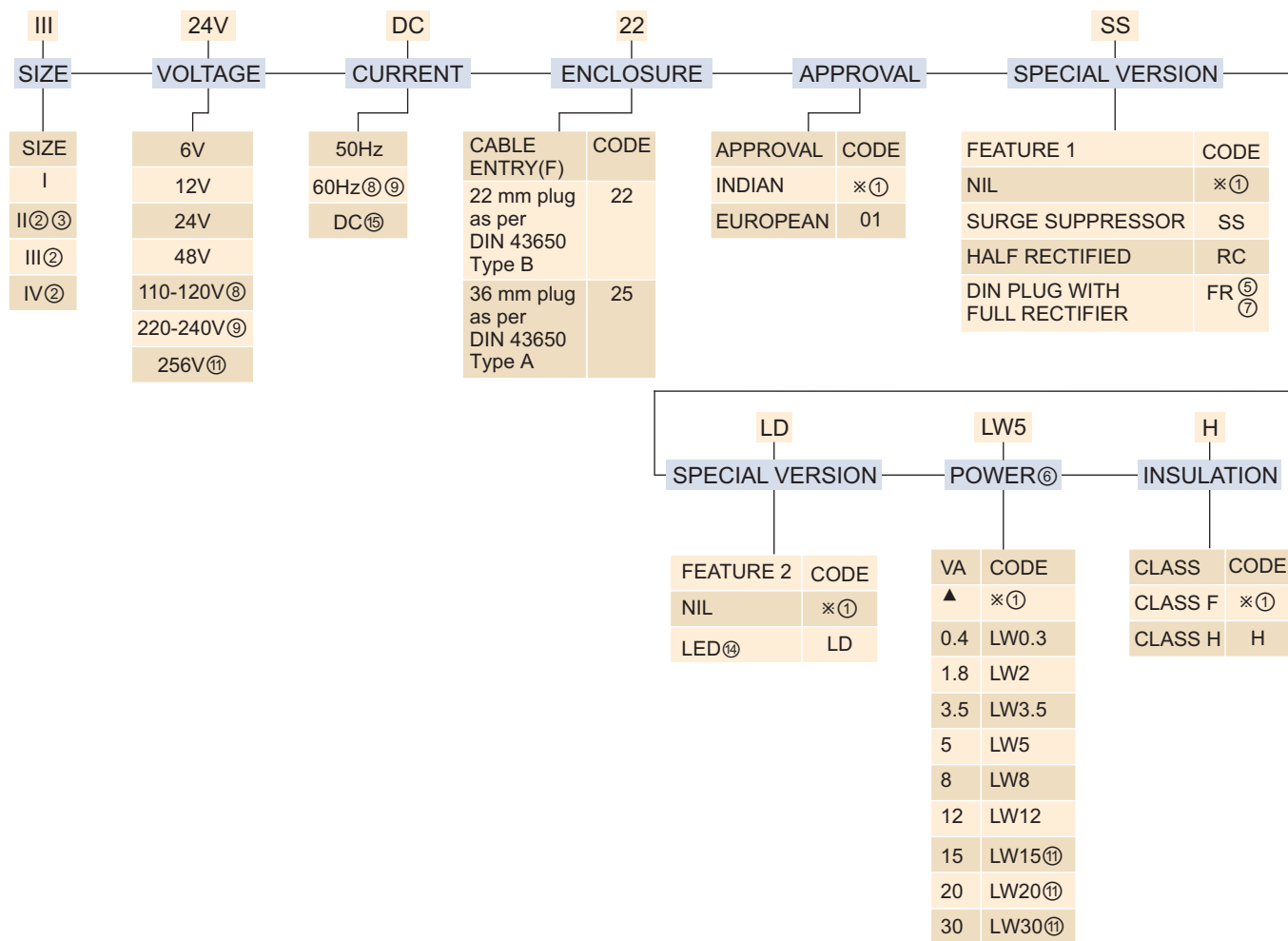

- NOTE :
- ① Do not specify
 - ② Select enclosure code 25
 - ③ Current 50 Hz, 60 Hz, Select Special version RC
 - ④ Select DC current coil to operate for 50 Hz or 60 Hz e.g. 110V DC-25-PR can be use for 110V 50 Hz or 120V, 60 Hz or DC
 - ⑤ Refer Power table on page 425A
 - ⑥ FR option will be available with coil type 25 only
 - ⑧ 110-120V 50 Hz Solenoid can be used for 110V 50 Hz, 120V 60 Hz
 - ⑨ 220-240V 50 Hz Solenoid can be used for 220-240V 50 Hz, 240V 60 Hz
 - ⑩ Select Special version PR for current 50 Hz or 60 Hz
 - ⑪ Voltage 24, 110, 220V current 50 Hz, 60 Hz, DC, LED provided in DIN plug
 - ⑫ 110-120V, 220-240V, current DC, size II, III

VOLTAGE VARIATION (For Continuous Duty only)

Rated Voltage	Operating Voltage
6	4.8V to 7.2V
12	9.6V to 14.4V
24	19.2V to 28.8V
48	38.4V to 57.6V
110-120	88V to 132V
220-240	176V to 264V
256	192V to 280V

DIN PLUG IN SOLENOID TYPE : 22, 25

DIMENSION SOLENOID TYPE : 22

Plug as per DIN 43650 Type B

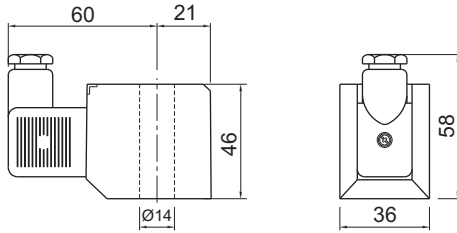

SOLENOID TYPE : 25

Plug as per DIN 43650 Type A

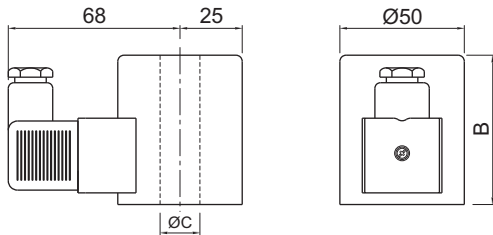

SIZE	ØC	B
III	13	43
II	18	60
IV	14	60
III	14	43

OBSELETE PRODUCTS AND ITS INTERCHANGEABILITY

 <p>Replace with Solenoid code 22 or 25 along with Guide & Plunger Assembly</p>	 <p>Replace with Solenoid coil code 22</p>			
--	---	--	--	--

CIRCUIT DIAGRAM

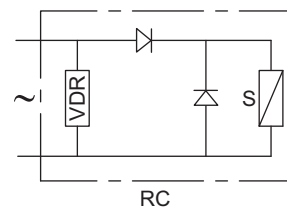
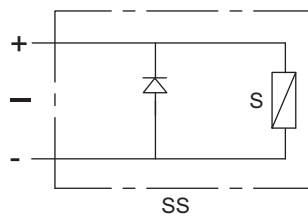
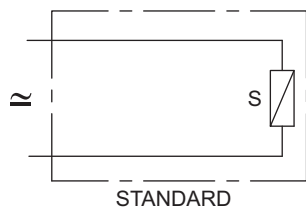

FEATURES

- Designed for extreme environmental condition
- Constructed for lowest temperature rise thus longer life
- 'O' Energiser for higher magnetic linkage
- Wider voltage variation



SPECIFICATION

Size	I-14 mm, II-18 mm, III-14 mm
Voltage	6 V, 12 V, 24 V, 48 V, 110 V, 120 V, 220 V
Current	50 Hz, 60 Hz, DC
Enclosure	Cable Entry Flying Leads Material Steel, Chrome Plated
Options	Surge Suppressor(SS)
Power	Refer to table "Power" on page 426A
Insulation Class	Class F optionally Class H
Weather Protection	IP54, Optionally IP67
Approval	Indian
Voltage Variation	Refer to Voltage Variation table (on page 426B)
Duty Cycle	100% (ED)
Ambient Temperature	-20 °C to 60 °C

WEIGHT IN kg

Size	Steel
I	0.2 kg
II	0.4 kg
III	0.3 kg

APPLICATION



INDOOR

FLYING LEAD SOLENOID TYPE : 01, 04, 06

POWER

Voltage	Solenoid		Power (VA)						
	Size	Core Dia					8	12	13
6	I	14					▲		
	II	18							▲
12	I	14					▲	▲	
	II	18							▲
24	I	14					▲	▲	
	II	18							▲
48	I	14					▲	▲	
	II	18							▲
110-120	I①	14						▲	
	II	18							▲
	III	14					▲		
220-240	I①	14						▲	
	II	18							▲
	III	14					▲		

▲ Standard

✓ Optional Available

① Select Current 50 Hz or 60 Hz

STANDARD POWER

Size	Current	Standard Power W, VA
I	AC	6, 12
	DC	8, 8
II	AC	13, 13
	DC	13, 13
III	AC	6, 12
	DC	8, 8

FLYING LEAD SOLENOID TYPE : 01, 04, 06

SOLENOID ORDERING CODE III-24V-DC-01-SS-H

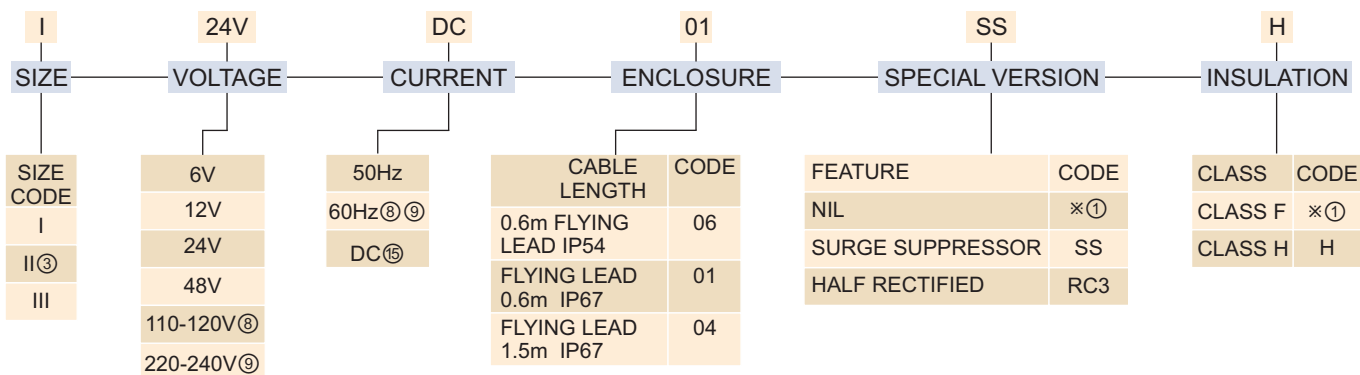

- NOTE :
- ① Do not specify
 - ③ Current 50 Hz, 60 Hz, Select Special version RC
 - ⑥ Refer Power table on page 426A
 - ⑧ 110-120V 50 Hz Solenoid can be used for 110V 50 Hz, 120V 60 Hz
 - ⑨ 220-240V 50 Hz Solenoid can be used for 220-240V 50 Hz, 240V 60 Hz
 - ⑮ 110-120V, 220-240V, DC can be supplied in Solenoid size II, III

VOLTAGE VARIATION (For Continuous Duty only)

Rated Voltage	Operating Voltage
6	4.8V to 7.2V
12	9.6V to 14.4V
24	19.2V to 28.8V
48	38.4V to 57.6V
110-120	88V to 132V
220-240	176V to 264V

FLYING LEAD SOLENOID TYPE : 01, 04, 06

DIMENSION

SOLENOID TYPE : 01, 04, 06

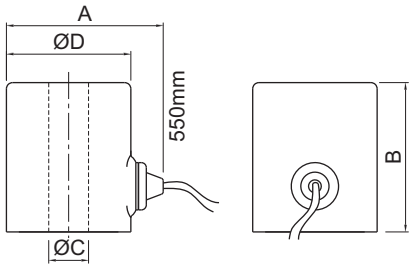

SIZE	A	B	ØC	ØD
I	56	42	14	42
II	64	60	18	50
III	63	43	14	50

OBSELETE PRODUCTS AND ITS INTERCHANGEABILITY

CIRCUIT DIAGRAM

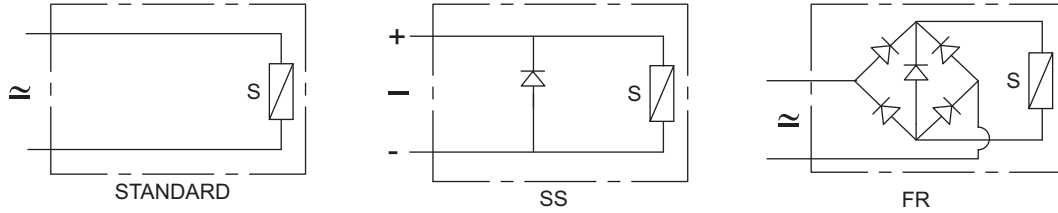

FEATURES

- Designed for extreme environmental condition
- Constructed for lowest temperature rise thus longer life
- 'O' Energiser for higher magnetic linkage
- Wider voltage variation
- UL Listed file number (applied for)

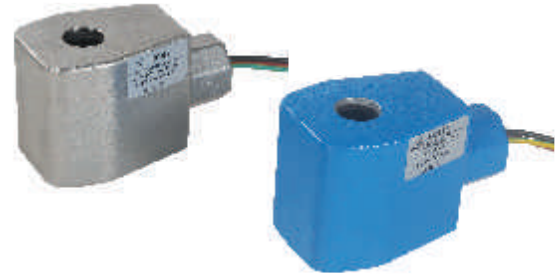

SPECIFICATION

Size	II- 18 mm, III- 13 mm, III & IV - 14 mm
Voltage	6 V, 12 V, 24 V, 110 V, 220 V, 256 V, 110-120V, 220-240V
Current	DC, 50/ 60 Hz/ DC
Enclosure	Cable Entry 1/2" NPT (F) Material Aluminum Cast, Polyester Powder coat, Colour Black/ Blue Stainless Steel casting
Options	Surge Suppressor(SS), Fully Rectified (FR), Low Power (LW) Manual Reset ON (MR)
Power	Refer to table "Power" on Page 427A
Insulation Class	Class H
Weather Protection	Type 3, 3S, 3R, 4, 4X, 6, 6P
Approval	UL Listed
Voltage Variation	Refer to Voltage Variation Table (on page 427B)
Duty Cycle	100% (ED)
Ambient Temperature	Power ≤ 20W, -60 °C to 100 °C, Power >20W, ≤30W, -60 °C to 70 °C

WEIGHT IN kg

Size	Al/ kg	SS/ kg
II	0.7	0.9
III	0.6	

APPLICATION



INDOOR



OUTDOOR

FLYING LEAD WITH CABLE ENTRY SOLENOID TYPE : 08

POWER

Voltage	Solenoid		Power (VA)					
	Size	Core Dia	0.4②	1.8②	3.5	8	13	30
6	II	18				✓	▲	
	III	13	✓					
	III	14		✓	✓	▲		
	IV	14		✓				
12	II	18				✓	▲	✓
	III	13	✓					
	III	14		✓	✓	▲		
	IV	14		✓				
24	II	18				✓	▲	✓
	III	13	✓					
	III	14		✓	✓	▲		
	IV	14		✓				
110-120	II	18				✓	▲	✓
	III	14			✓	▲		
220-240	II	18				✓	▲	✓
	III	14				▲		
256②	II	18				✓	▲	✓
	III	14				▲		

▲ Standard

✓ Optional Available

② Select Current DC

STANDARD POWER

Size	Current	Standard Power W, VA
I	AC	6, 12
	DC	8, 8
II	AC	13, 13
	DC	13, 13
III	AC	6, 12
	DC	8, 8

FLYING LEAD WITH CABLE ENTRY SOLENOID TYPE : 08

SOLENOID ORDERING CODE

III-24V-DC-08-H-02

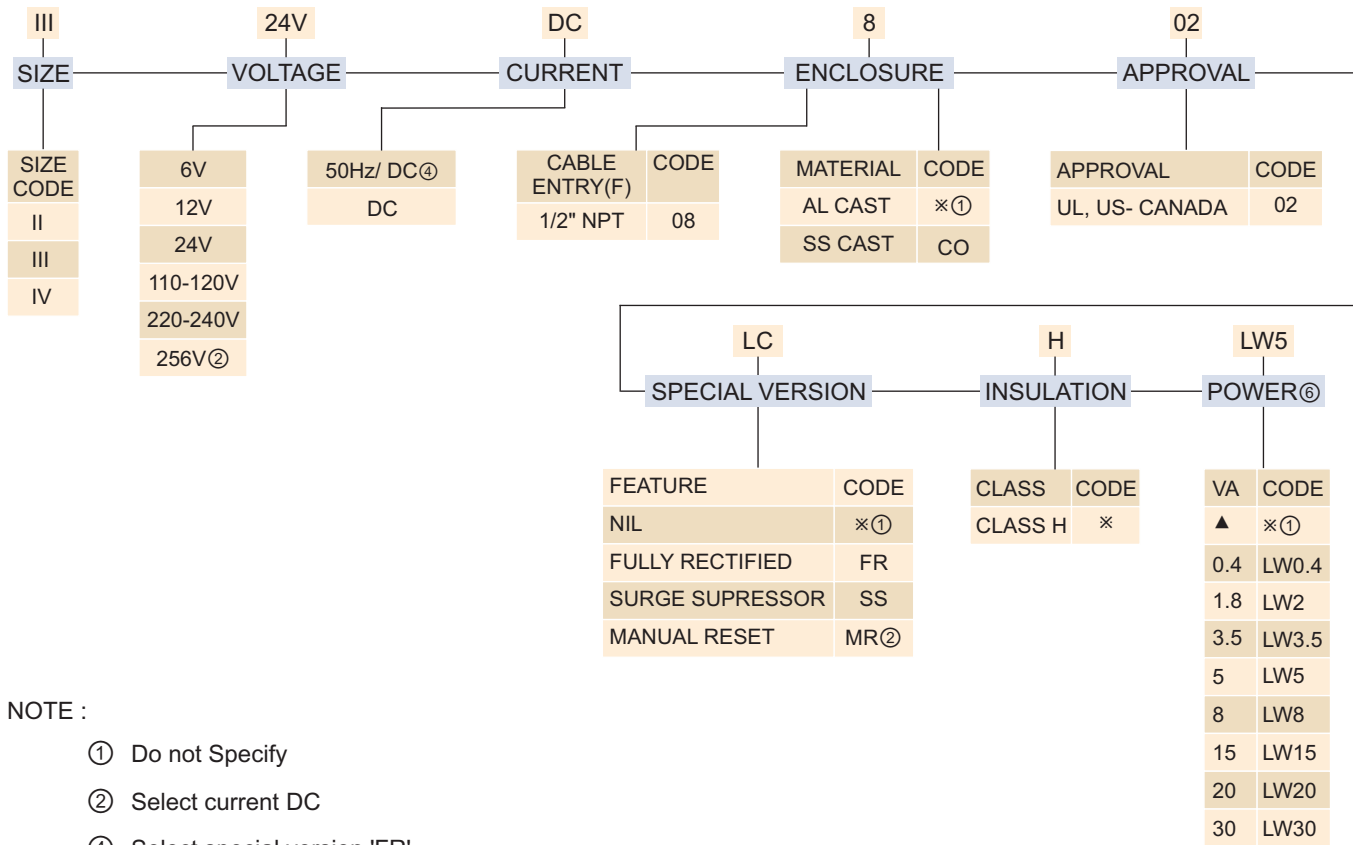

NOTE :

- ① Do not Specify
- ② Select current DC
- ④ Select special version 'FR'
- ⑥ Refer Power table on page 427A

VOLTAGE VARIATION (For Continuous Duty only)

Rated Voltage	Operating Voltage
6	4.8V to 7.2V
12	9.6V to 14.4V
24	19.2V to 28.8V
48	38.4V to 57.6V
110-120	88V to 132V
220-240	176V to 264V
256	192V to 280V

DIMENSION

SOLENOID TYPE : 08

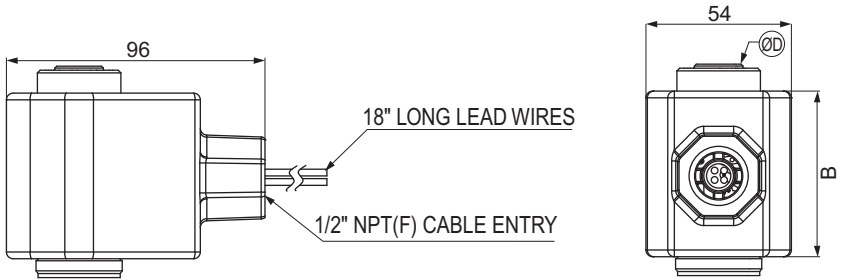

SIZE	B	ØD*
II	61	18
III	47	14
IV	61	14

OBSELETE PRODUCTS AND ITS INTERCHANGEABILITY

TERMINAL BOX SOLENOID TYPE : 16, 19

CIRCUIT DIAGRAM

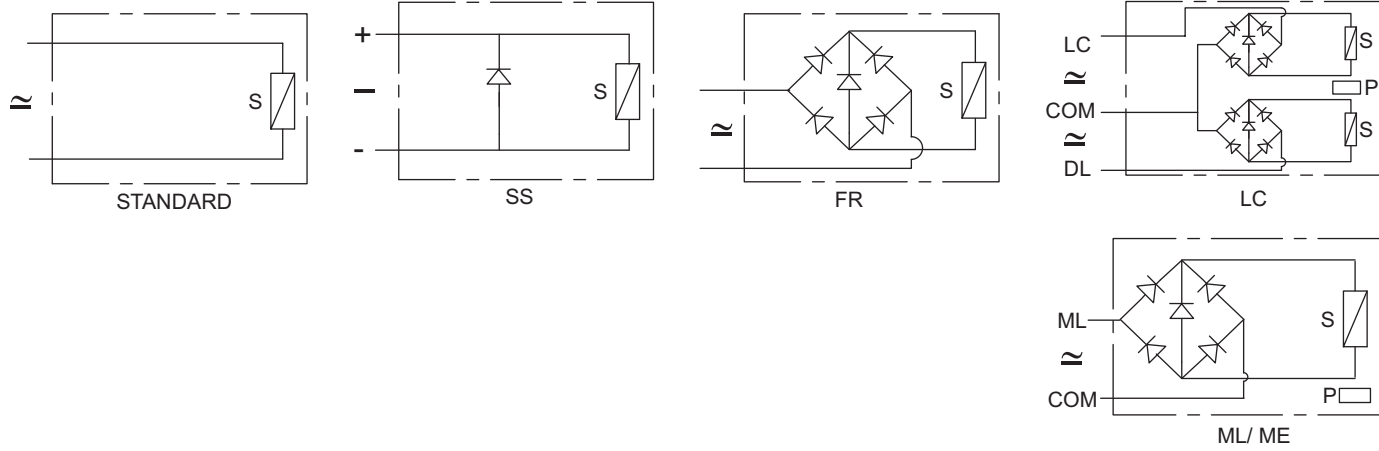

FEATURES

- Designed for extreme environmental condition
- With Integrated terminal box and Horizontal cable entry
- Wider voltage & frequency variation
- 'O' energiser for higher magnetic linkage
- Large terminals for easy connections
- Internal as well as external earth terminal
- Constructed for lowest temperature rise thus longer life



SPECIFICATION

Size	I- 14 mm, II- 18 mm, III- 13 mm, III & IV - 14 mm
Voltage	6 V, 12 V, 24 V, 48 V, 110 V, 120 V, 220 V, 256 V
Current	50 Hz, 60 Hz, DC, 50/ 60 Hz/ DC
Enclosure	Cable Entry M25X1.5, Adopted to M20 X 1.5 or 1/2" NPT Material Aluminum Cast Painting : Polyester Powder coated Stainless Steel Cast, Optionally Polyester Powder coated Painted
Options	Surge Suppressor(SS), Fully Rectified (FR), Latch (LC), Latch, Manual Reset OFF (ML), Manual Reset ON (MR), LED (LD)
Power	Refer to table "Power" on Page 428A
Insulation Class	Class F, Optionally Class H
Weather Protection	IP67, Optionally IP67M, IP68
Approval	Indian, European, SIL
Voltage Variation	Refer to Voltage Variation Table (on page 428B)
Duty Cycle	100% (ED)
Ambient Temperature	Class F, Power ≤ 13W, -40 °C to 75 °C Class H, Power ≤ 13W, -40 °C to 100 °C, Power ≥ 13W, -40 °C to 75 °C

WEIGHT IN kg

Size	Al	SS
I	0.5	1.2
II	0.8	1.7
III	0.6	1.4
IV	0.8	1.6

APPLICATION



INDOOR



OUTDOOR

TERMINAL BOX SOLENOID TYPE : 16, 19

POWER

Voltage	Solenoid		Power (VA)							
	Size	Core Dia	0.4②	1.8②	3.5	5	8	12	13	30
6	I	14					▲			
	II	18					✓		▲	
	III	13	✓							
	III	14		✓	✓		▲			
	IV	14		✓						
12	I	14		✓			▲	▲		
	II	18					✓		▲	✓
	III	13	✓							
	III	14		✓	✓		▲			
	IV	14		✓						
24	I	14		✓			▲	▲		
	II	18					✓		▲	✓
	III	13	✓							
	III	14		✓	✓	✓	▲			
	IV	14		✓						
48	I	14					▲	▲		
	II	18							▲	✓
	III	14		✓	✓		▲			
	IV	14		✓						
110-120	I①	14				✓	▲	▲		
	II	18					✓		▲	✓
	III	14			✓		▲			
220-240	I①	14				✓	▲	▲		
	II	18					✓		▲	✓
	III	14					▲			
256②	II	18					✓		▲	✓
	III	14				✓	▲			
440④	III	14						▲		

- ▲ Standard
- ✓ Optional Available
- ① Select Current 50 Hz or 60 Hz
- ② Select Current DC
- ④ Select Current 50 Hz

STANDARD POWER

Size	Current	Standard Power W, VA
I	AC	6, 12
	DC	8, 8
II	AC	13, 13
	DC	13, 13
III	AC	6, 12
	DC	8, 8

TERMINAL BOX SOLENOID TYPE : 16, 19

SOLENOID ORDERING CODE

III - 24DC - 16 - A - SS - LD - LW5 - H

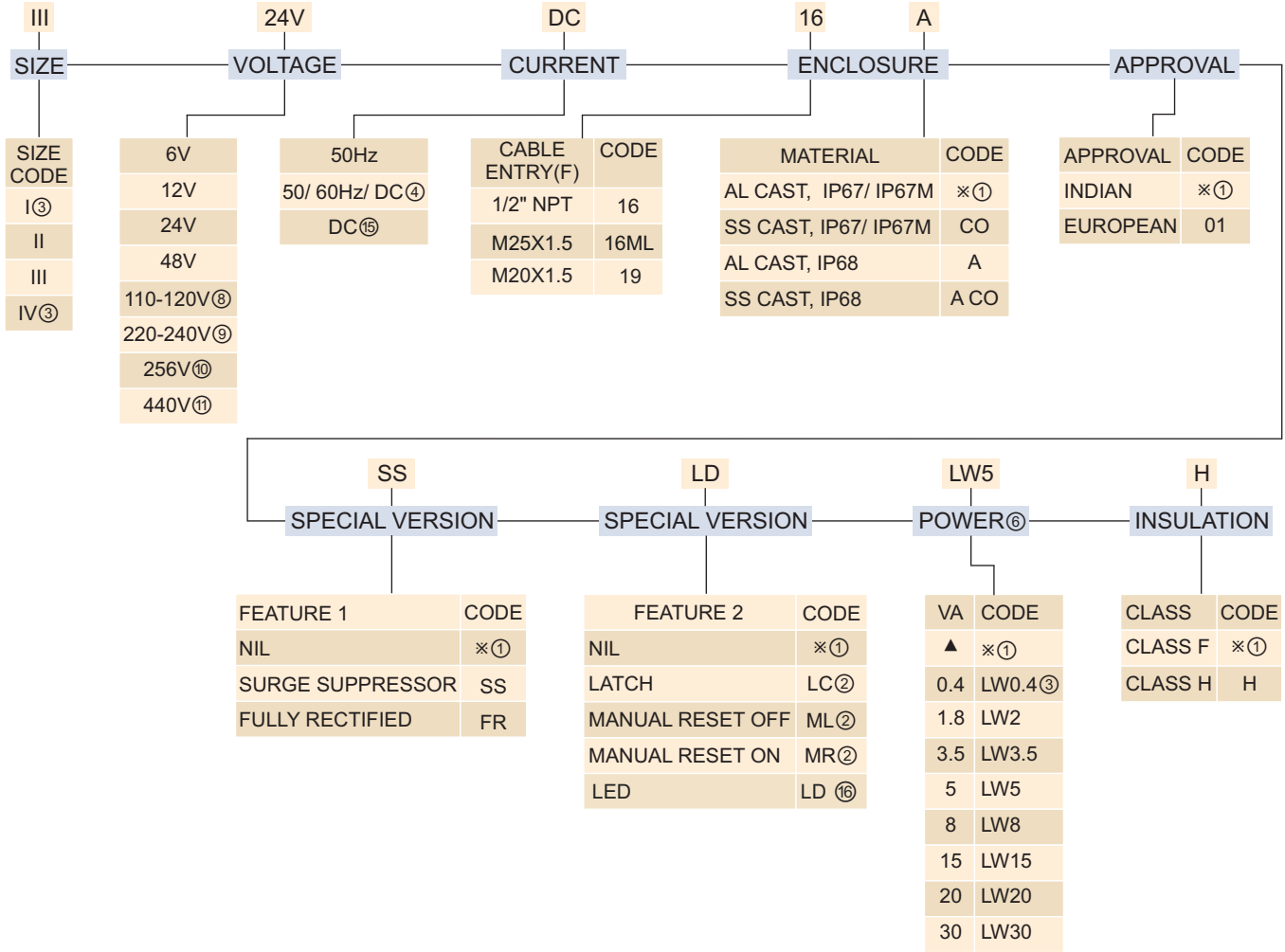

NOTE : ^① Do not specify

^② Voltage 24V, 110-120V, 220-240V current 50/ 60 Hz/ DC power standard size II/ III

^③ Current 50/ 60 Hz/ DC Special version FR can not be opted

^④ Select Option FR for 50/ 60 Hz/ DC current

^⑥ Refer Power table on page 428A

^⑧ 110-120V 50 Hz Solenoid can be used for 110V 50 Hz, 120V 60 Hz

^⑨ 220-240V Solenoid can be used for 220-240V 50 Hz, 240V 60 Hz

^⑩ Only for DC current

^⑪ Current 50 Hz, Size III

^⑫ 110-120V, 220-240V, DC can be supplied in Solenoid size II, III

^⑬ Size II & III Only

VOLTAGE VARIATION (For Continuous Duty only)

Rated Voltage	Operating Voltage
6	4.8V to 7.2V
12	9.6V to 14.4V
24	19.2V to 28.8V
48	38.4V to 57.6V
110-120	88V to 132V
220-240	176V to 264V
256	192V to 280V
440	350V to 480V



TERMINAL BOX SOLENOID TYPE : 16, 19

DIMENSION SOLENOID TYPE : 16

CABLE ENTRY M20X1.5

CABLE ENTRY
Include drwg. with adopter
16 MS
16

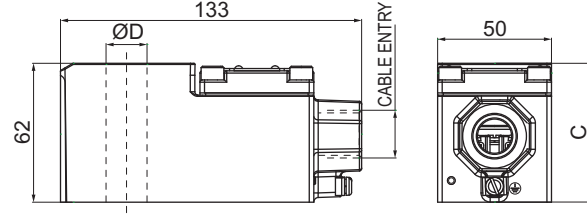
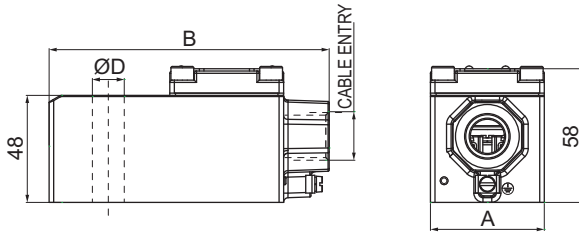

SIZE	A	B	ØD
I	42	116	14
III	50	124	14
III	50	124	13

SIZE	C	ØD
II	61	18
IV	51	14

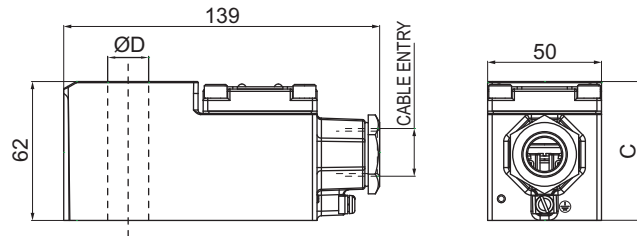
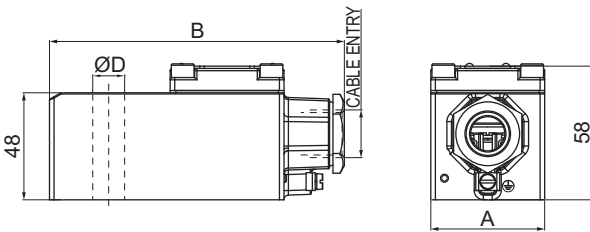

CABLE ENTRY M20X1.5 & 1/2" NPT (With Adopter)



SIZE	A	B	ØE
I	42	122	14
III	50	130	14
III	50	130	13

SIZE	C	ØD
II	61	18
IV	51	14

OBSELETE PRODUCTS AND ITS INTERCHANGEABILITY

 <p>Replace with Solenoid code 16 or 16MS along with Guide and Plunger assembly</p>	 <p>Solenoid Type 19 Replace with coil code 16MS</p>			
--	---	--	--	--

TERMINAL BOX (BCE) TYPE : 17

CIRCUIT DIAGRAM

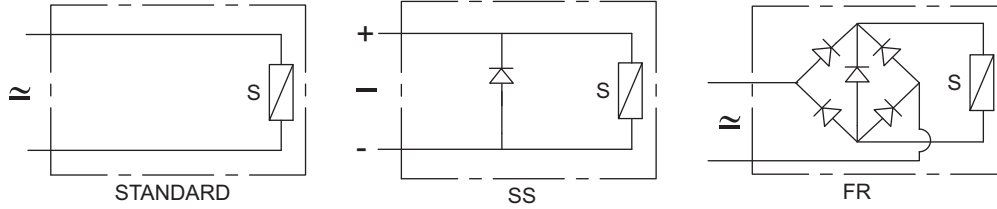

FEATURES

- Designed for extreme environmental condition
- Large terminals for easy connection
- Constructed for lowest temperature rise thus longer life
- 'O' Energiser for higher magnetic linkage
- Wider voltage variation
- Bottom Cable entry to avoid rain or process fluid entering into the termination area.
- For ease of operation and maintenance LED can be provided to confirm availability of voltage to the coil terminals
- UL Listed, file number E342217
- Dual gasket for better weather proof protection

UL



SPECIFICATION

Size	II - 18 mm, III - 13 mm, III & IV - 14 mm	
Voltage	6 V, 12 V, 24 V, 110 V, 120 V, 220 V, 256 V	
Current	50 Hz, 60 Hz, DC, 50/ 60 Hz/ DC	
Enclosure	Cable Entry	M25 X 1.5, Adopted to M20 X 1.5 or 1/2" NPT
	Material	Aluminum Cast colour Blue polyester powder coat, Stainless Steel Cast
Options	Surge Suppressor (SS), Fully Rectified (FR), Low Power (LW), Manual Reset (MR)	
Power	Refer to table "Power" on page 428E	
Insulation Class	Class H	
Weather Protection	Type 3, 35, 4, 4X, 6, 6P	
Approval	UL Listed	
Voltage Variation	Refer to Voltage Variation table on page 428F	
Duty Cycle	100% (ED)	
Ambient Temperature	Power ≤ 20W, -60 °C to 100 °C, Power ≥ 20W, -60 °C to 75 °C	

WEIGHT IN kg

Size	Al/ kg	SS/ kg
II	0.9	1.6
III	0.8	1.4

APPLICATION



INDOOR



OUTDOOR

TERMINAL BOX (BCE) TYPE : 17

POWER

Voltage	Solenoid		Power (VA)							
	Size	Core Dia	0.4②	1.8②	3.5	5	8	12	13	30
6	II	18					✓		▲	
	III	13	✓							
	III	14		✓	✓		▲			
	IV	14		✓						
12	II	18					✓		▲	✓
	III	13	✓							
	III	14		✓	✓		▲			
	IV	14		✓						
24	II	18					✓		▲	✓
	III	13	✓							
	III	14		✓	✓		▲			
	IV	14		✓						
48	II	18							▲	
	III	13					▲			
110-120	II	18					✓		▲	✓
	III	13								
	III	14				✓	▲	▲		
	IV	14								
220-240	II	18					✓		▲	✓
	III	14			✓		▲	▲		
	IV	14								
256②	II	18					✓		▲	✓
	III	14					▲			
	IV	14								

- ▲ Standard
- ✓ Optional Available
- ② Only for DC Current

STANDARD POWER

Size	Current	Standard Power W, VA
I	AC	6, 12
	DC	8, 8
II	AC	13, 13
	DC	13, 13
III	AC	6, 12
	DC	8, 8

TERMINAL BOX (BCE) TYPE : 17

SOLENOID ORDERING CODE

III-24V-DC-17-CO-SS-LD-LW5-H-02

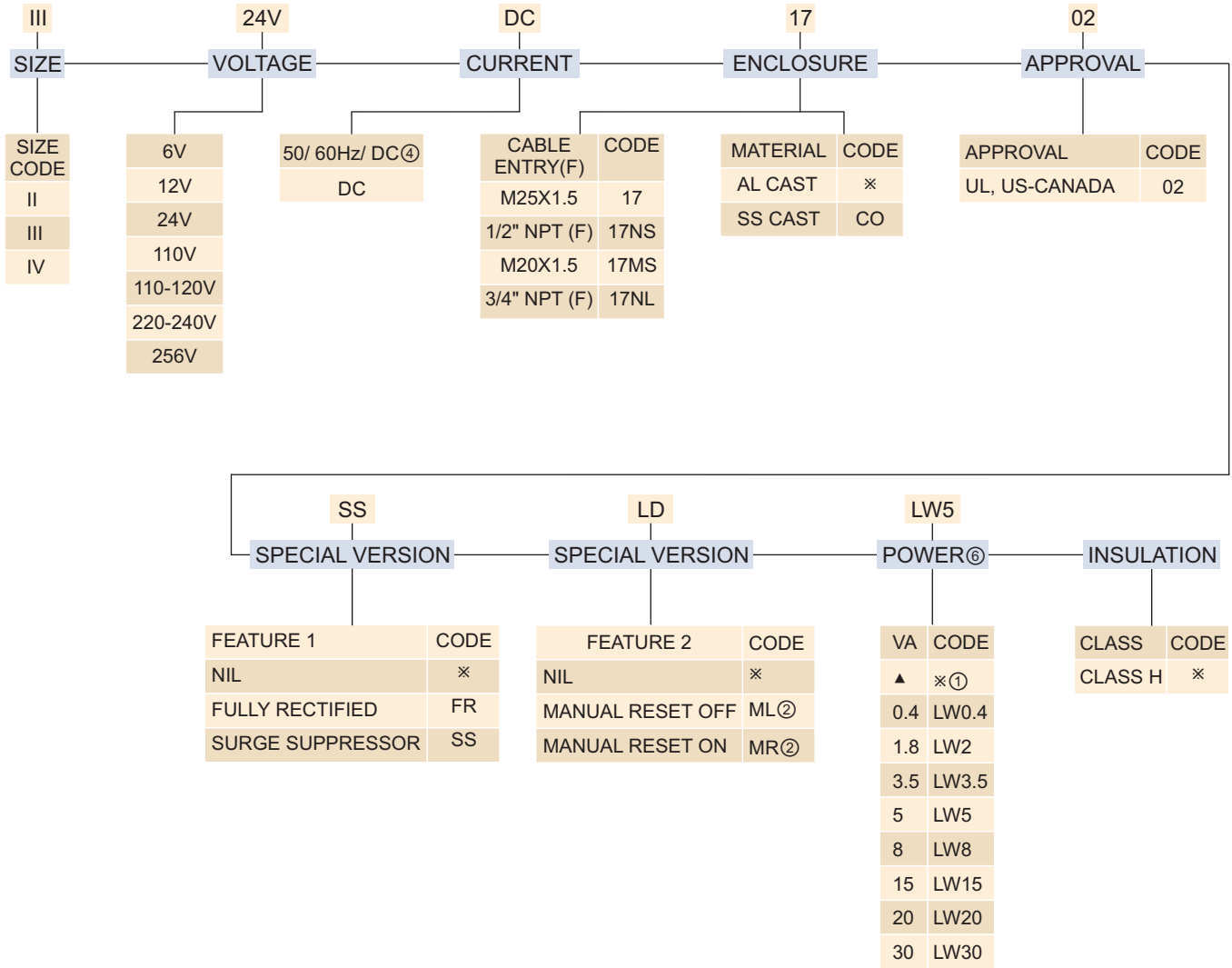

- NOTE :
- ① Do not specify
 - ② Available in size II and III select power standard voltage 24V, 110-120V, 220-240V
 - ④ Select special version FR

- ⑥ Refer Power table on page 428E for size, Voltage and Power
- ⑧ 110-120V 50 Hz Solenoid can be used for 110V 50 Hz, 120V 60 Hz
- ⑨ 220-240V Solenoid can be used for 220-240V 50 Hz, 240V 60 Hz

VOLTAGE VARIATION (For Continuous Duty only)

Rated Volatge	Operating Voltage
6	4.8V to 7.2V
12	9.6V to 14.4V
24	19.2V to 28.8V
48	38.4V to 57.6V
110-120	88V to 132V
220-240	176V to 264V
256	192V to 280V

TERMINAL BOX (BCE) TYPE : 17

MARKING

ROTEX AUTOMATION LIMITED
www.rotexautomation.com



CE **UL** **US** TYPE 3, 3R, 3S, 4, 4X, 6 & 6P

MODEL : III-110-120V-50Hz-60Hz/DC-7-02-FR-LW5

SR. NO. : 15100100 - 07/14-081

Ambient Temperature
-60 °C to 100 °C POWER ≤ 20W
-60 °C to 70 °C > 20W POWER ≤ 30W

DUTY CYCLE : CONTINUOUS

DIMENSION SOLENOID TYPE : 17

WITH CABLE ENTRY M25X1.5

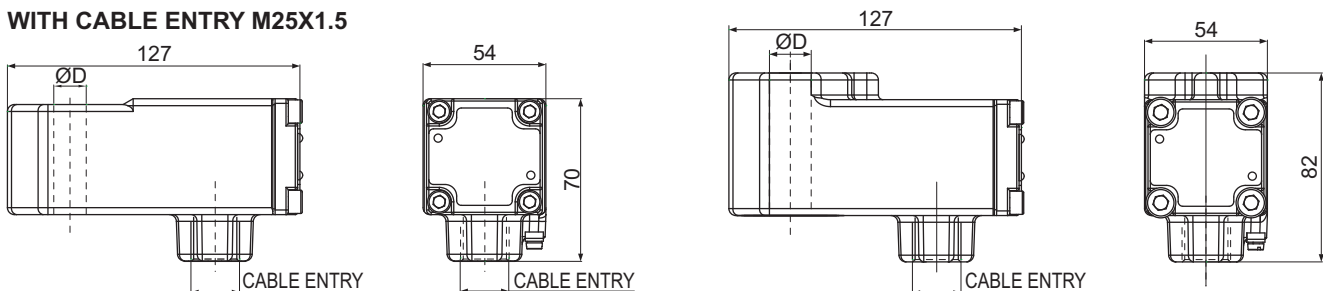

	ØD
III	13
III	14

	ØD
II	18
IV	14

CABLE ENTRY M20X1.5, 1/2" NPT(F) (With Adopter)

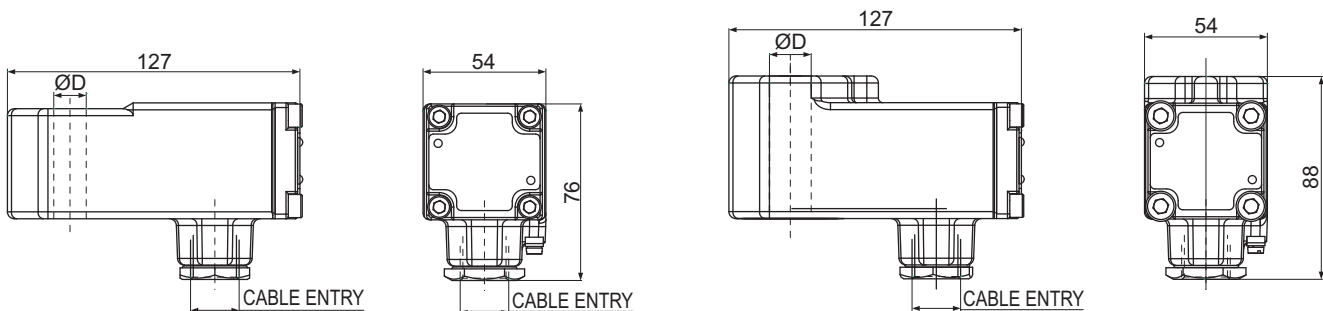

	ØD
III	13
III	14

	ØD
II	18
IV	14

OBSELETE PRODUCTS AND ITS INTERCHANGEABILITY

--	--	--	--

CIRCUIT DIAGRAM

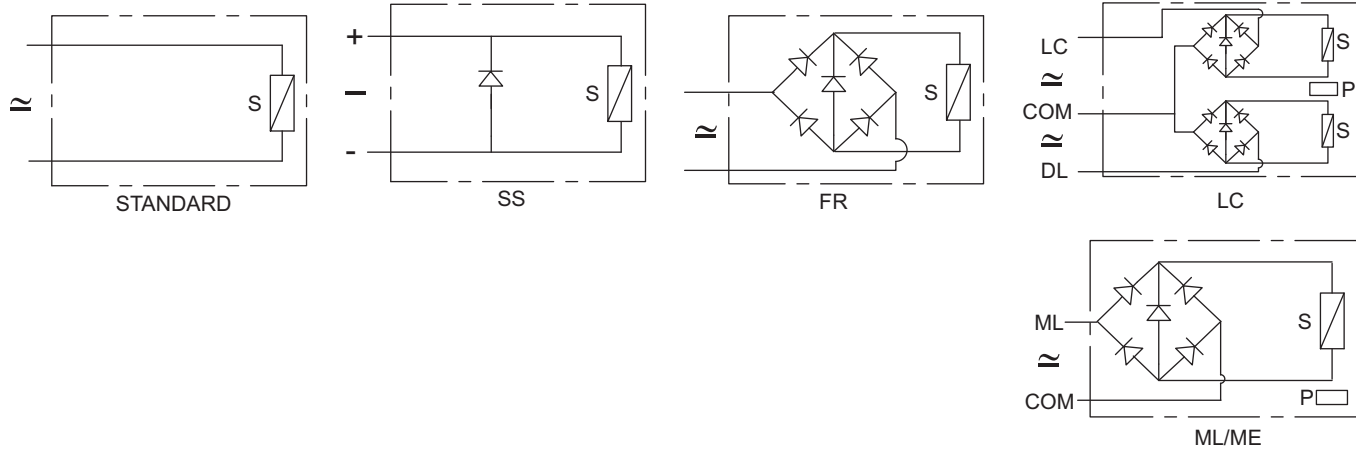

FEATURES

- Designed for extreme environmental condition
- With Integrated terminal box and Horizontal cable entry
- Large terminals for easy connections
- Constructed for lowest temperature rise thus longer life
- 'O' Energiser for higher magnetic linkage
- Wider voltage variation
- Surger Suppressor Provided
- Dual gasket



SPECIFICATION

Size	I- 14 mm, II- 18 mm, III- 13 mm, III & IV - 14 mm
Voltage	6 V, 12 V, 24 V, 48 V, 110 V, 120 V, 220 V, 256 V
Current	50 Hz, 60 Hz, DC, 50/ 60/ DC
Enclosure	<p>Cable Entry M25X1.5, Adopted to M20X1.5 or 1/2" NPT ((INDIAN Approval) M20X1.5, 1/2" NPT (37-01, 39-01) (Other than INDIAN Approval)</p> <p>Material Aluminum Cast, Polyester Powder coat, Colour Red Stainless Steel Cast, Painted Optionally Grey Polyester Powder coat</p>
Options	Corrosive Environment (CO), Manual Reset ON (MR ON), Manual Reset OFF (MR OFF), Low Power (LW), Latch (LC), Surge Suppressor(SS), Fully Rectified (FR)
Power	Refer to table "Power" on page 429A
Insulation Class	Class F optionally Class H (INDIAN Approval) Class H (Other than INDIAN Approval)
Weather Protection	IP66, IP67, IP67M (Refer marking on page 429C)
Approval	INDIAN, ATEX, CU-TR, INMETRO, CCOE, DGMS, SIL
Voltage Variation	Refer to Voltage Variation table on page 429B
Duty Cycle	100% (ED)
Ambient Temperature	Refer to Ambient temperature table on page 429C

WEIGHT IN kg

Size	AI	SS
I	0.5	1.2
II	0.8	1.7
III	0.6	1.4
IV	0.8	1.6

APPLICATION



INDOOR



OUTDOOR



POWER

Voltage	Solenoid		Power (VA)							
	Size	Core Dia	0.4②	1.8②	3.5	5	8	12	13	30
6	I	14					▲			
	II	18					✓		▲	
	III	13	✓							
	III	14		✓	✓		▲			
	IV	14		✓						
12	I	14		✓③			▲	▲		
	II	18					✓		▲	✓
	III	13	✓							
	III	14		✓	✓		▲			
	IV	14		✓						
24	I	14		✓③			▲	▲		
	II	18					✓		▲	✓
	III	13	✓							
	III	14		✓	✓	✓	▲			
	IV	14		✓						
48	I	14		✓③			▲	▲		
	II	18							▲	✓
	III	14		✓	✓		▲			
	IV	14		✓						
110-120	I①	14				✓③		▲		
	II	18					✓		▲	✓
	III	14			✓	✓	▲			
220-240	I①	14						▲		
	II	18					✓		▲	✓
	III	14				✓	▲			
256②	II	18					✓		▲	✓
	III	14					▲			
440④	III	14						▲		

- ▲ Standard
- ✓ Optional Available

- ① Current 50 Hz or 60 Hz
- ② Only for DC Current
- ③ Should be Opted for 3/2 & 5/2 pilot operated valve
- ④ Current 50 Hz only

STANDARD POWER

Size	Current	Standard Power W, VA
I	AC	6, 12
	DC	8, 8
II	AC	13, 13
	DC	13, 13
III	AC	6, 12
	DC	8, 8

SOLENOID ORDERING CODE

III-24V-DC-37-CO-SS-LD-LW5-H

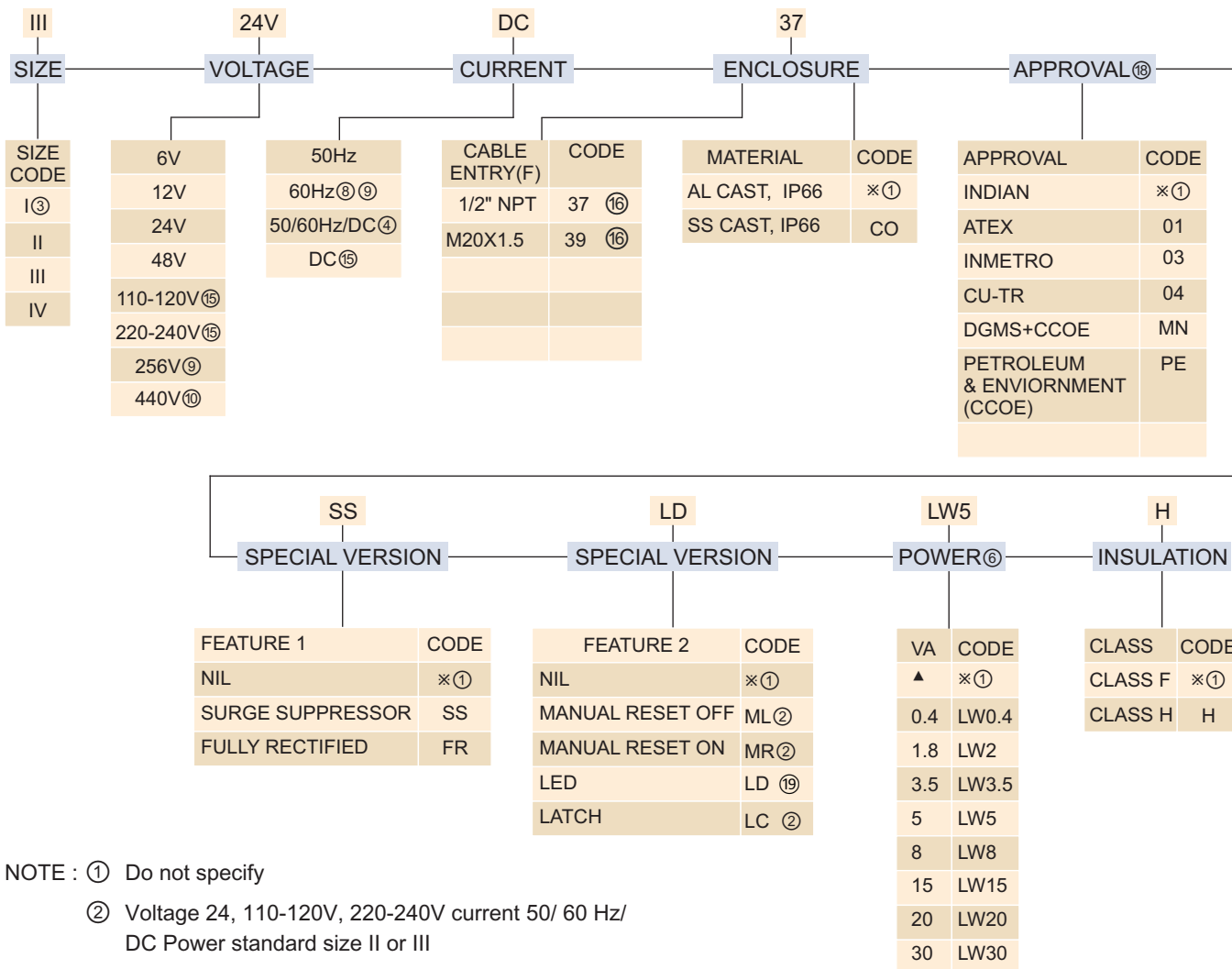

- NOTE :
- ① Do not specify
 - ② Voltage 24, 110-120V, 220-240V current 50/ 60 Hz/ DC Power standard size II or III
 - ③ Current 50/ 60 Hz/ DC & Special version FR can not be opted
 - ④ Select special version FR
 - ⑥ Refer Power table on page 429A
 - ⑧ 110-120V 50 Hz Solenoid can be used for 110V 50 Hz, 120V 60 Hz
 - ⑨ 220-240V 50 Hz Solenoid can be used for 240V 60 Hz, 220-240V 50 Hz
 - ⑩ 50 Hz current, Size III only
 - ⑮ Current DC size II, III
 - ⑯ IP67 Certified by IS, CCOE/ PESO, D MS
 - ⑰ Add SL for SIL capable certified coil
 - ⑱ Size II & III Only

VOLTAGE VARIATION (For Continuous Duty only)

Rated Voltage	Operating Voltage
6	4.8V to 7.2V
12	9.6V to 14.4V
24	19.2V to 28.8V
48	38.4V to 57.6V
110-120	88V to 132V
220-240	176V to 264V
256	205V to 280V
440	350V to 480V

APPROVAL

Approval	certifying Agencies	reference Number
INDIAN	CMRI	KLPL/Ex/R/12-007
	KLPL (Re-Validated)	CMRI/TC/P/H-1415
BIS INDIAN		7229976
CCOE/ PESO INDIAN		P-218046/1
DGMS INDIAN		230 of 2011
EUROPEAN/ ATEX	CESI, Italy	CESI 03 ATEX 344 Extension No. 01/12
INMETRO	CEPEL	CEPEL 08-1717X
CU-TR		RU C-IN.Г508.B.01100



MARKING

Marking	Ambient Temperature
ATEX	
II 2GD Ex d IIC T6 Gb Ex tb IIIC T80 °C Db IP66	- 40 °C ≤ Ta < 35 °C
II 2GD Ex d IIC T5 Gb Ex tb IIIC T95 °C Db IP66	- 40 °C ≤ Ta ≤ 50 °C
II 2GD Ex d IIC T4 Gb Ex tb IIIC T130 °C Db IP66	- 40 °C ≤ Ta ≤ 60 °C
INDIAN, CCOE/PESO, DGMS Refer to Table for Ambient Temp.	
Ex d IIC Tx IP67	- 20 °C ≤ Ta ≤ AA °C
INMETRO	
II 2GD Ex d IIC T6 Gb Ex tb IIIC T85 °C Db IP66	- 40 °C ≤ Ta < 35 °C
II 2GD Ex d IIC T5 Gb Ex tb IIIC T100 °C Db IP66	- 40 °C ≤ Ta ≤ 50 °C
II 2GD Ex d IIC T4 Gb Ex tb IIIC T135 °C Db IP66	- 40 °C ≤ Ta ≤ 60 °C
CU-TR	
1 Ex d IIC T6 Gb X/Ex tb IIIC T80 °C Db	- 40 °C to 35 °C
1 Ex d IIC T5 Gb X/Ex tb IIIC T95 °C Db	- 40 °C to 50 °C
1 Ex d IIC T4 Gb X/Ex tb IIIC T130 °C Db	- 40 °C to 60 °C

AMBIENT TEMPERATURE

(INDIAN Approval)

SIZE	MAX. POWER	MAX. AMBIENT TEMP. °C		
		T6 (80)	T5 (95)	T4 (130)
I	5	65	70	-
	8	60	70	-
III	5	70	-	-
	8	60	70	-
	15	50	65	70
II	8	65	70	-
	10	60	70	-
	13	60	70	-
	20	55	70	-
IV	30	40	55	70
	5	70	-	-
	11	65	70	-

DIMENSION

SOLENOID TYPE : 37 & 39

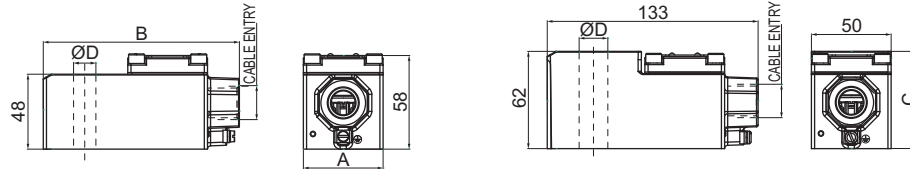

SIZE	A	B	ØD	COIL TYPE	CABLE ENTRY	APPROVAL INDIAN	OTHER THAN INDIAN	SIZE	C	ØD
I	42	116	14	37	M25X1.5(F)	✓		II	61	18
III	50	124	14	37	1/2"NPT(F)		✓	IV	51	14
III	50	124	13	39	M20X1.5(F)		✓			
				37NS	1/2"NPT(F)	✓				
				37MS	M20X1.5(F)	✓				

CABLE ENTRY M20X1.5, 1/2" NPT(F) (With Ex Adopter) (INDIAN Approval)

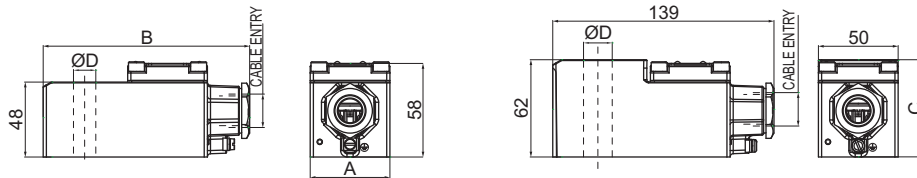

SIZE	A	B	ØD	COIL TYPE	CABLE ENTRY	APPROVAL INDIAN	SIZE	C	ØD
I	42	122	14	37	1/2"NPT(F)	✓	II	61	18
III	50	130	14	39	M20X1.5(F)	✓	IV	51	14
III	50	130	13	37MS	M20X1.5(F)	✓			
				37NS	1/2"NPT(F)	✓			

OBSELETE PRODUCTS AND ITS INTERCHANGEABILITY

<p>Replace Solenoid code 37 or 37MS along with Guide & Plunger assembly</p>	<p>Replace Solenoid code 37 or 37MS along with Guide & Plunger assembly</p>	<p>Solenoid code 39 replace with Solenoid code 37MS</p>		
---	---	---	--	--



CIRCUIT DIAGRAM

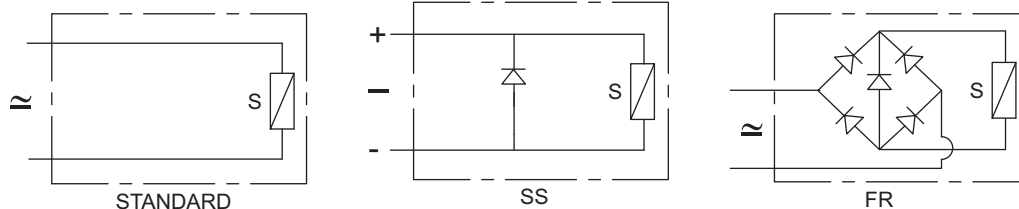

FEATURES

- Designed for extreme environmental condition
- Constructed for lowest temperature rise thus longer life
- 'O' Energiser for higher magnetic linkage
- Wider voltage variation
- UL Listed file number (applied for)

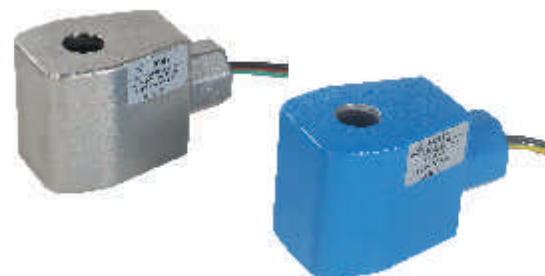

SPECIFICATION

Size	II- 18 mm, III- 13 mm, III & IV - 14 mm
Voltage	6 V, 12 V, 24 V, 110 V, 120 V, 220 V, 256 V
Current	50 Hz, 60 Hz, DC, 50/ 60 Hz/ DC
Enclosure	Cable Entry 1/2" NPT (F) Material Aluminum Cast, Polyester Powder coated, Colour Blue Stainless Steel casting
Options	Surge Suppressor(SS), Fully Rectified (FR), Manual Reset ON (MR)
Power	Refer to table "Power" on Page 431A
Insulation Class	Class H
Weather Protection	Type 3, 3S, 3R, 4, 4X, 6, 6P* 7 & 9
Approval	UL Listed
Voltage Variation	Refer to Voltage Variation Table (on page 431B)
Duty Cycle	100% (ED)
Ambient Temperature	Power ≤ 20W, -60 °C to 100 °C, Power ≥ 20W, -60 °C to 75 °C

* Applied for

WEIGHT IN kg

Size	Al/ kg	SS/ kg
II	0.7	0.9
III	0.5	

APPLICATION



INDOOR



OUTDOOR

POWER

Voltage	Solenoid		Power (VA)						
	Size	Core Dia	0.4②	1.8②	3.5	5	8	13	30
6	II	18		✓			✓	▲	
	III	13	✓						
	III	14			✓		▲		
	IV	14		✓					
12	II	18		✓			✓	▲	✓
	III	13	✓						
	III	14			✓		▲		
	IV	14		✓					
24	II	18		✓			✓	▲	✓
	III	13	✓						
	III	14			✓	✓	▲		
	IV	14		✓					
110-120	II	18					✓	▲	✓
	III	13							
	III	14			✓	✓	▲		
220-240	II	18					✓	▲	✓
	III	14				✓	▲		
256②	II	18					✓	▲	✓
	III	14					▲		

▲ Standard

✓ Optional Available

② Only for DC Current

STANDARD POWER

Size	Current	Standard Power W, VA
I	AC	6, 12
	DC	8, 8
II	AC	13, 13
	DC	13, 13
III	AC	6, 12
	DC	8, 8

SOLENOID ORDERING CODE III-24V-DC-56-H-01

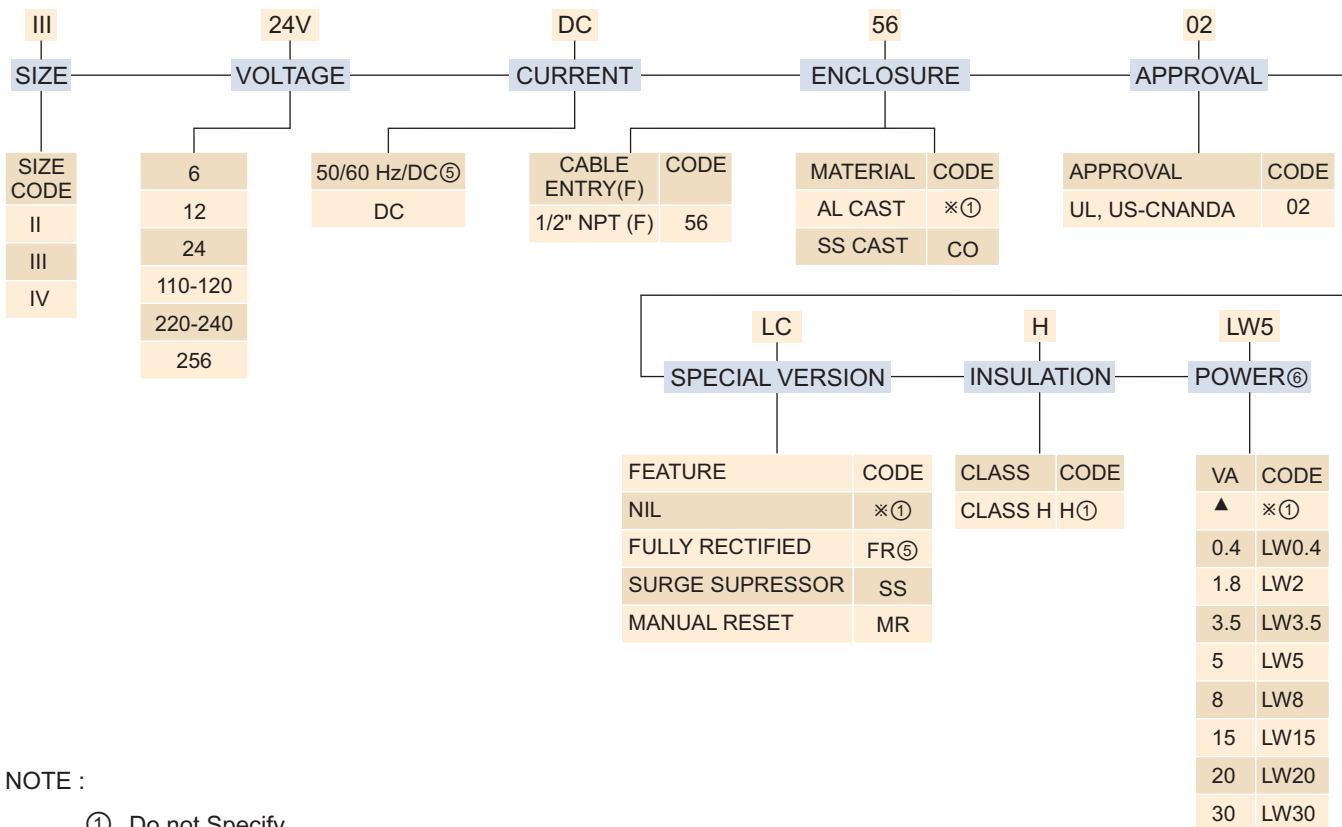

NOTE :

- ① Do not Specify
- ⑤ Solenoid suitable for 50 Hz/ 60 Hz/ DC current, select special version FR
- ⑥ Refer Power table on page 430A

VOLTAGE VARIATION (For Continuous Duty only)

Rated Voltage	Operating Voltage
6	4.8V to 7.2V
12	9.6V to 14.4V
24	19.2V to 28.8V
48	38.4V to 57.6V
110-120	88V to 132V
220-240	176V to 264V
256	192V to 280V

DIMENSION

SOLENOID TYPE : 56

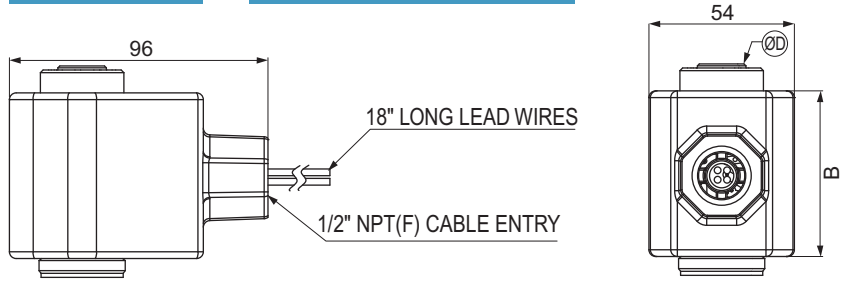

SIZE	B	ØD*
II	61	18
III	47	14
IV	61	14
III	47	13

CIRCUIT DIAGRAM

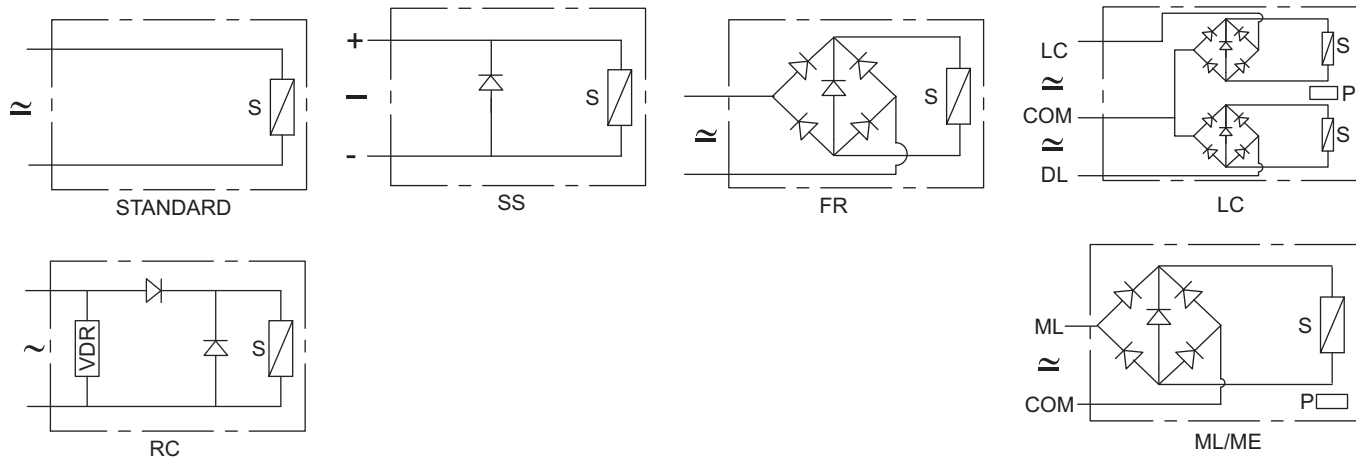

FEATURES

- Designed for extreme environmental condition
- Integrated terminal box having Horizontal cable entry
- Large terminals for easy connections
- Constructed for lowest temperature rise thus longer life
- 'O' Energiser for higher magnetic linkage
- Wider voltage variation
- Can in be installed zone 1, 2, 21, 22



SPECIFICATION

Size	I- 14 mm, II- 18 mm, III- 13 mm, III & IV - 14 mm
Voltage	6 V, 12 V, 24 V, 48 V, 110 V, 120 V, 230 V, 256 V
Current	50 Hz, 60 Hz, DC, 50-60Hz DC
Enclosure	Cable Entry M25X1.5, Adapted to M20X1.5 or 1/2" NPT Material Aluminum Cast, Polyester Powder coated, Colour Black Stainless Steel Cast
Options	Corrosive Environment (CO), Manual Reset ON (MR), Manual Reset, OFF (ML), Low Power (LW), Latch (LC), Surge Suppressor(SS), Fully Rectified (FR), Half Rectified (RC)
Power	Refer to table "Power" on page 430E
Insulation Class	Class H
Weather Protection	IP67
Approval	ATEX
Voltage Variation	Refer to Voltage Variation table on page 430F
Duty Cycle	100% (ED)
Ambient Temperature	-60 °C to 70 °C Refer to Marking table on page 430G

WEIGHT IN kg

Size	Al	SS
I	0.5	1.2
II	0.8	1.7
III	0.7	1.4
IV	0.8	1.6

APPLICATION



INDOOR



OUTDOOR

POWER

Voltage	Solenoid		Power (VA)							
	Size	Core Dia	1.0 ^②	1.8 ^②	3.5	5	8	12	13	30
6 ^②	I	14					▲			
	II	18							▲	
	III	13								
	III	14								
	IV	14								
12	I ^⑤	14					▲			
	II	18							▲	
	III	13	✓ ^③							
	III	14		✓ ^③	✓					
	IV	14		✓						
24	I ^⑤	14		✓ ^③			▲	▲		
	II	18					✓		▲	✓
	III	13	✓ ^③							
	III	14		✓ ^③	✓	✓	▲			
	IV	14		✓						
48	I ^⑤	14					▲			
	II	18							▲	
	III	14					▲			
	IV	14								
110-120	I ^{①⑤}	14						▲		
	II	18					✓		▲	✓
	III	14			✓	✓	▲			
220-240	I ^{①⑤}	14						▲		
	II	18					✓		▲	✓
	III	13								
	III	14				✓	▲			
256 ^②	II	18							▲	✓
	III	14					▲			

- ▲ Standard
- ✓ Optional Available

- ① Current 50 Hz or 60 Hz
- ② Only for DC Current
- ③ Should be Opted for 3/2 & 5/2 pilot operated valve
- ④ Current 50 Hz only
- ⑤ Current 50 Hz, 60Hz or DC

STANDARD POWER

Size	Current	Standard Power W, VA
I	AC	6, 12
	DC	8, 8
II	AC	13, 13
	DC	13, 13
III	AC	6, 12
	DC	8, 8

SOLENOID ORDERING CODE III-24V-DC-58-CO-SS-LD-LW5

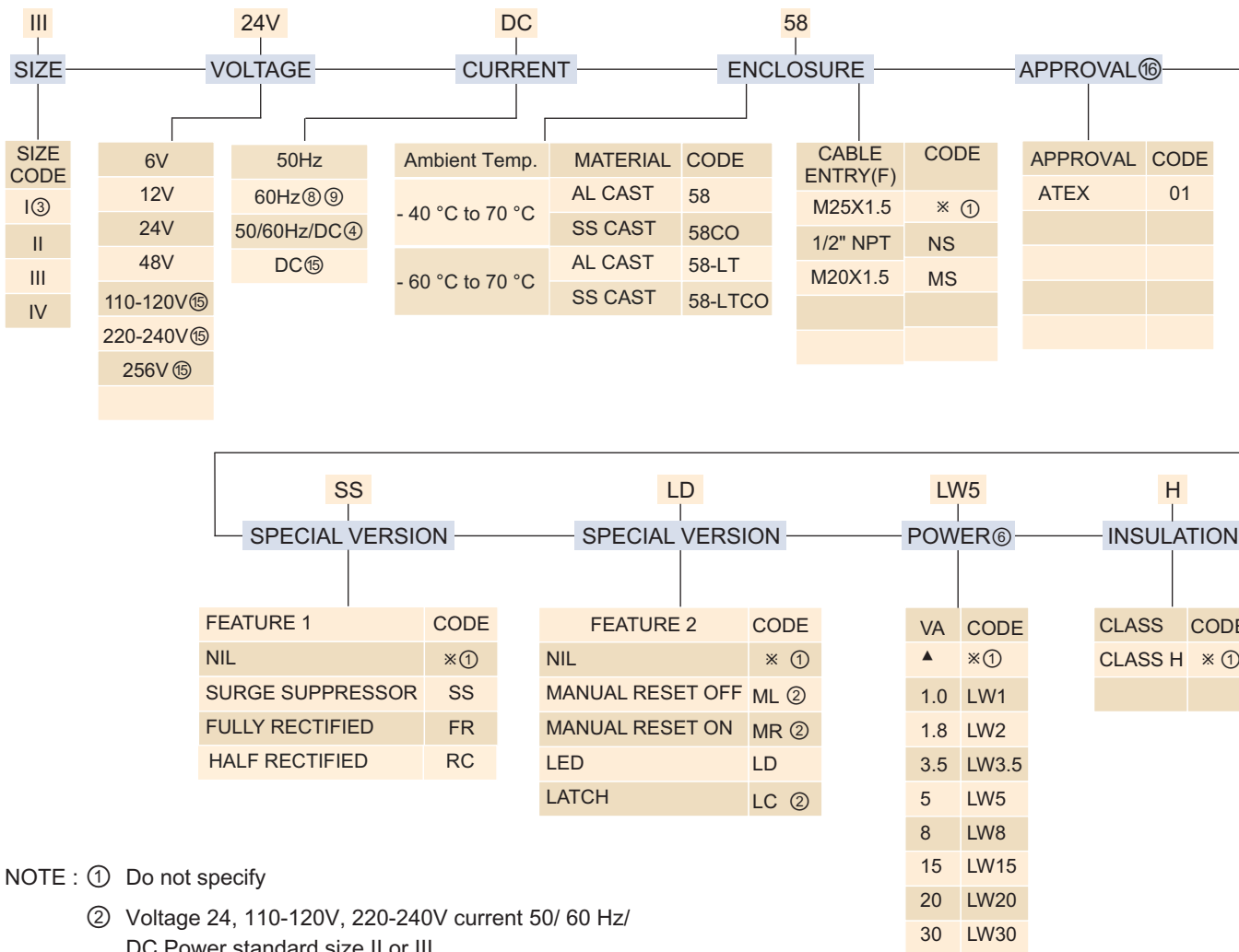

NOTE : ① Do not specify

② Voltage 24, 110-120V, 220-240V current 50/ 60 Hz/ DC Power standard size II or III

③ Current 50 Hz/ 60 Hz or DC, Special version FR can not be opted

④ Select special version FR, Size II, III, IV

⑥ Refer Power table on page 430E

⑧ 110-120V 50 Hz Solenoid can be used for 110V 50 Hz, 120V 60 Hz

⑨ 220-240V 50 Hz Solenoid can be used for 240V 60 Hz, 220-240V 50 Hz

⑮ Current DC size II, III, IV

⑯ Add SL for SIL capable certified coil

VOLTAGE VARIATION (For Continuous Duty only)

Rated Voltage	Operating Voltage
6	4.8V to 7.2V
12	9.6V to 14.4V
24	19.2V to 28.8V
48	38.4V to 57.6V
110-120	88V to 132V
220-240	176V to 264V
256	205V to 280V

APPROVAL

Approval	Certifying Agencies	Reference Number
EUROPEAN/ ATEX	TEKNIKA INSPECIA, a.s.	1408X

MARKING

SOLENOID TYPE 58

Size III 15W Coil

EX e mb IIC T6 - T4 Gb IP67
 Ex tb IIIC T6 - T4 °C Db IP67
 -40 °C ≤ Ta ≤ 50 °C for T6
 -40 °C ≤ Ta ≤ 65 °C for T5
 -40 °C ≤ Ta ≤ 70 °C for T4

Size III 5W Coil

EX e mb IIC T6 Gb IP67
 Ex tb IIIC T6 °C Db IP67
 -40 °C ≤ Ta ≤ 70 °C for T6

Size III 8W, Size II 10W
 Size I 8W, Size II 13W

EX e mb IIC T6 - T5 Gb IP67
 Ex tb IIIC T6 - T5 °C Db IP67
 -40 °C ≤ Ta ≤ 60 °C for T6
 -40 °C ≤ Ta ≤ 70 °C for T5

Size II 20W Coil

EX e mb IIC T6 - T5 Gb IP67
 Ex tb IIIC T6 - T5 °C Db IP67
 -40 °C ≤ Ta ≤ 55 °C for T6
 -40 °C ≤ Ta ≤ 70 °C for T5

Size II 8W,
 Size I 5W, Size IV 11W

EX e mb IIC T6 - T5 Gb IP67
 Ex tb IIIC T6 - T5 °C Db IP67
 -40 °C ≤ Ta ≤ 60 °C for T6
 -40 °C ≤ Ta ≤ 70 °C for T5

Size II 30W Coil

EX e mb IIC T6 - T4 Gb IP67
 Ex tb IIIC T6 - T4 °C Db IP67
 -40 °C ≤ Ta ≤ 40 °C for T6
 -40 °C ≤ Ta ≤ 55 °C for T5
 -40 °C ≤ Ta ≤ 70 °C for T4

SOLENOID TYPE 58-LT

Size III 15W Coil

EX e mb IIC T6 - T4 Gb IP67
 Ex tb IIIC T6 - T4 °C Db IP67
 -60 °C ≤ Ta ≤ 50 °C for T6
 -60 °C ≤ Ta ≤ 65 °C for T5
 -60 °C ≤ Ta ≤ 70 °C for T4

Size III 5W Coil

EX e mb IIC T6 Gb IP67
 Ex tb IIIC T6 °C Db IP67
 -60 °C ≤ Ta ≤ 70 °C for T6

Size III 8W, Size II 10W
 Size I 8W, Size II 13W

EX e mb IIC T6 - T5 Gb IP67
 Ex tb IIIC T6 - T5 °C Db IP67
 -60 °C ≤ Ta ≤ 60 °C for T6
 -60 °C ≤ Ta ≤ 70 °C for T5

Size II 20W Coil

EX e mb IIC T6 - T5 Gb IP67
 Ex tb IIIC T6 - T5 °C Db IP67
 -60 °C ≤ Ta ≤ 55 °C for T6
 -60 °C ≤ Ta ≤ 70 °C for T5

Size II 8W,
 Size I 5W, Size IV 11W

EX e mb IIC T6 - T5 Gb IP67
 Ex tb IIIC T6 - T5 °C Db IP67
 -60 °C ≤ Ta ≤ 60 °C for T6
 -60 °C ≤ Ta ≤ 70 °C for T5

Size II 30W Coil

EX e mb IIC T6 - T4 Gb IP67
 Ex tb IIIC T6 - T4 °C Db IP67
 -60 °C ≤ Ta ≤ 40 °C for T6
 -60 °C ≤ Ta ≤ 55 °C for T5
 -60 °C ≤ Ta ≤ 70 °C for T4

DIMENSION

SOLENOID TYPE : 58, 58-LT

SIZE	A	B	ØD
I	42	116	14
III	51	124	14

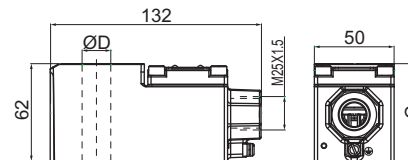
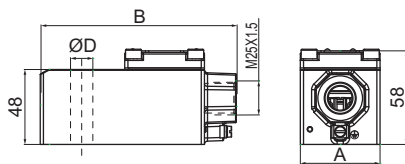

SIZE	C	ØD
II	58	18
IV	58	14

CABLE ENTRY M20X1.5, 1/2" NPT(F) (With Adopter)

SIZE	A	B	ØD
I	42	122	14
III	51	130	14

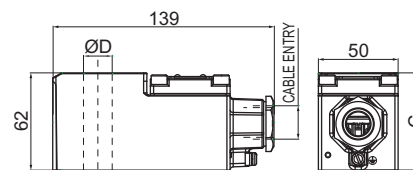
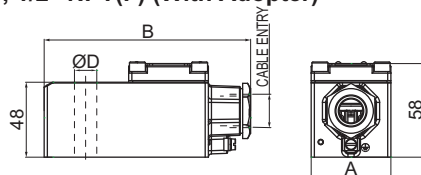

SIZE	C	ØD
II	58	18
IV	58	14

CIRCUIT DIAGRAM

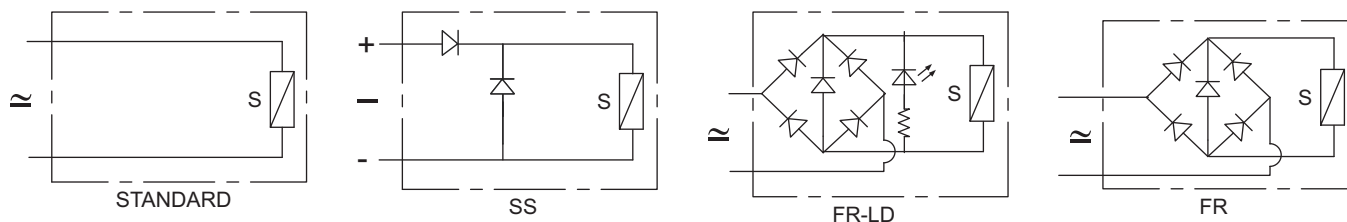

FEATURES

- Designed for extreme environmental condition
- Large terminals for easy connections
- Constructed for lowest temperature rise thus longer life
- 'O' Energiser for higher magnetic linkage
- Wider voltage variation
- Bottom Cable entry to avoid rain or process fluid entering into the termination area.
- For ease of operation and maintenance LED can be provided to confirm availability of voltage to the Solenoid terminals
- Dual gasket



SPECIFICATION

Size	II - 18 mm, III - 14 mm, IV - 14 mm	
Voltage	6 V, 12 V, 24 V, 48 V, 110 V, 120 V, 220 V, 256 V	
Current	50 Hz, 60 Hz, DC, 50 Hz/ 60 Hz/ DC	
Enclosure	Cable Entry	M25 X 1.5, Adopted to M20 X 1.5 or 1/2" NPT
	Material	Aluminum Cast, Polyester Powder Coat, Colour Blue Stainless Steel Cast
Options	Surge Suppressor (SS), Fully Rectified (FR), LED (LD), Low Power (LW), Manual Reset (MR)	
Power	Refer to table "Power" on page 431A	
Insulation Class	Class H	
Weather Protection	IP67, IP67 M Optionally IP68	
Approval	INDIAN, ATEX, CU-TR, IECEx, CCOE, DGMS ①, SIL	
Voltage Variation	Refer to Voltage Variation table on page 431B	
Duty Cycle	100% (ED)	
Ambient Temperature	Refer to Ambient temperature table on page 429C	

① DGMS applied for

WEIGHT IN kg

Size	Al	SS
II	0.9	1.6
III	0.8	1.4
IV	0.9	1.6

APPLICATION



INDOOR



OUTDOOR

POWER

Voltage	Solenoid		Power (VA)							
	Size	Core Dia	0.4②	1.8②	3.5	5	8	12	13	30
6	II	18					✓		▲	
	III	13	✓							
	III	14		✓	✓	✓	▲			
	IV	14		✓						
12	II	18					✓		▲	✓
	III	13	✓							
	III	14		✓	✓	✓	▲	▲		
	IV	14		✓						
24	II	18					✓		▲	✓
	III	13	✓							
	III	14		✓	✓	✓	▲	▲		
	IV	14		✓						
48	II	18							▲	✓
	III	13								
	III	14		✓	✓	✓	▲	▲		
	IV	14								
110-120	II	18					✓		▲	✓
	III	14				✓	▲	▲		
220-240	II	18					✓		▲	✓
	III	14				✓	▲	▲		
256②	II	18					✓		▲	✓
	III	14					▲			
	IV	14								

▲ Standard

✓ Optional Available

② Only for DC Current

③ Should be Opted for 3/2 & 5/2 pilot operated valves

STANDARD POWER

Size	Current	Standard Power W, VA
I	AC	6, 12
	DC	8, 8
II	AC	13, 13
	DC	13, 13
III	AC	6, 12
	DC	8, 8

SOLENOID ORDERING CODE

III-24V-DC-87-CO-SS-LD-LWS-H-07

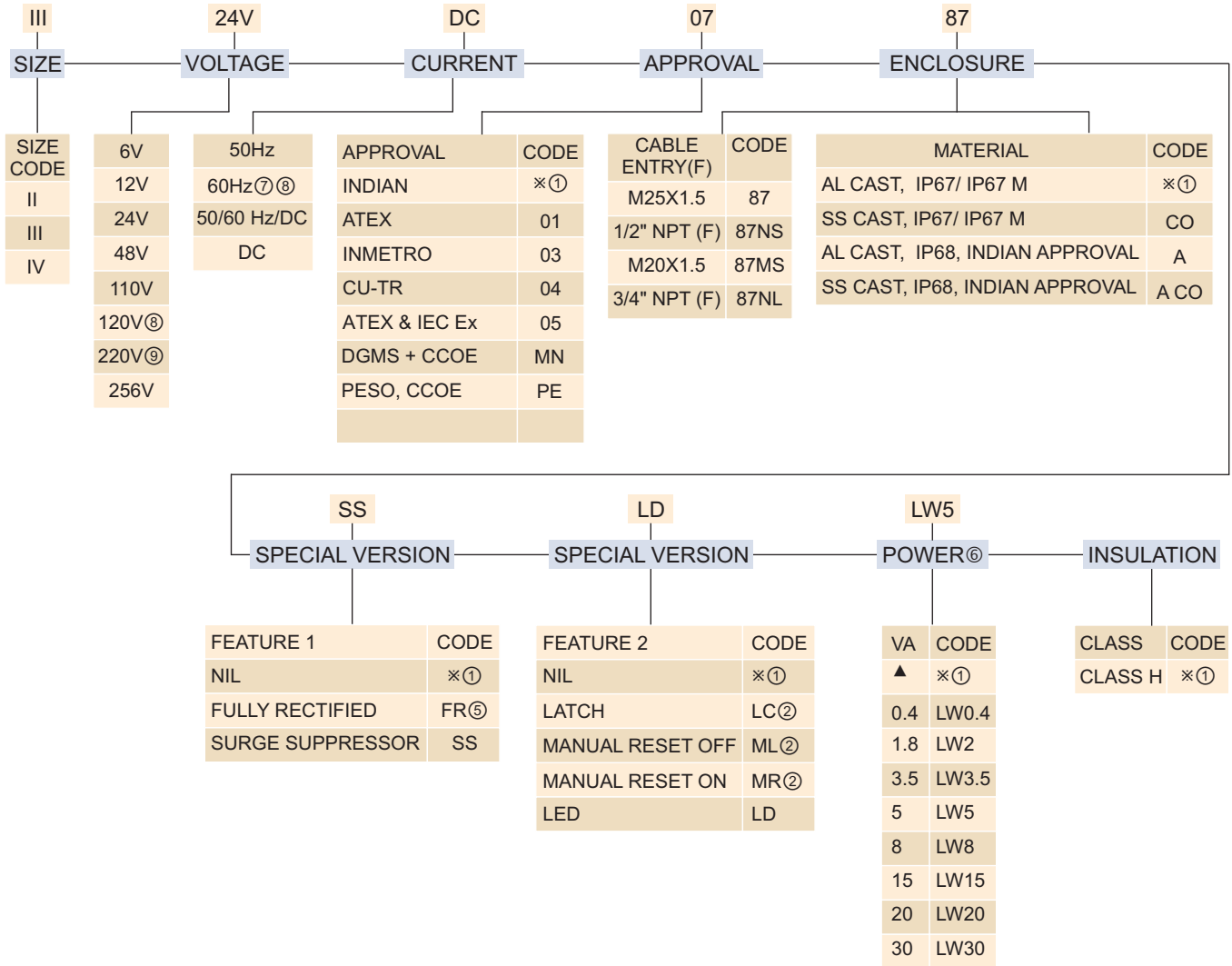

NOTE : ^① Do not specify
^② Voltage 24V, 110-120V, 220-240V current
 50-60 Hz/ DC power standard
 size II or III

^⑤ Solenoid suitable for 50 Hz/ 60 Hz/ DC current, Select special version FR
^⑥ Refer Power table on page 430A
^⑧ 110-120V 50 Hz Solenoid can be used for 110V 50 Hz, 120V 60 Hz
^⑨ 220-240V Solenoid can be used for 220-240V 50 Hz, 240V 60 Hz

VOLTAGE VARIATION (For Continuous Duty only)

Rated Volatge	Operating Voltage
6	4.8V to 7.2V
12	9.6V to 14.4V
24	19.2V to 28.8V
48	38.4V to 57.6V
110-120	88V to 132V
220-240	176V to 264V
256	192V to 280V



MARKING

Temperature Class	Ambient
ATEX, IECEx	
II 2GD Ex d IIC T6 Gb Ex tb IIIC T80 °C Db IP67	- 60 °C < Ta < XX °C
II 2GD Ex d IIC T5 Gb Ex tb IIIC T95 °C Db IP67	- 60 °C < Ta < XX °C
II 2GD Ex d IIC T4 Gb Ex tb IIIC T130 °C Db IP67	- 60 °C < Ta < XXX °C
II 2GD Ex d IIC T3 Gb Ex tb IIIC T155 °C Db IP67	- 60 °C < Ta < XXX °C
INDIAN, DGMS, CCOE	
Ex d IIC T6 Gb Ex tb IIIC T80 °C Db IP67/ IP67 M/IP68	- 60 °C < Ta < XX °C
Ex d IIC T5 Gb Ex tb IIIC T95 °C Db IP67/ IP67 M/IP68	- 60 °C < Ta < XX °C
Ex d IIC T4 Gb Ex tb IIIC T130 °C Db IP67/ IP67 M/IP68	- 60 °C < Ta < XXX °C
Ex d IIC T3 Gb Ex tb IIIC T155 °C Db IP67/ IP67 M/IP68	- 60 °C < Ta < XXX °C
CU-TR	
Ex d IIC T6 IP67 Ex tb IIIC T80 °C Db IP67	- 60 °C < Ta < 70 °C
Ex d IIC T5 IP67 Ex tb IIIC T95 °C Db IP67	- 60 °C < Ta < 70 °C
Ex d IIC T4 IP67 Ex tb IIIC T130 °C Db IP67	- 60 °C < Ta < 100 °C
Ex d IIC T3 IP67 Ex tb IIIC T155 °C Db IP67	- 60 °C < Ta < 100 °C

AMBIENT TEMPERATURE

SIZE	MAX. POWER	MAX. AMBIENT TEMPERATURE °C			
		T6	T5	T4	T3
III	5	65	80	100	
	8	60	75	100	
	15	50	65	100	
II	8	65	80	100	
	13	60	75	100	
	20		45	80	100
	30			60	70
IV	5	70	85	100	
	11	65	80	100	

- e.g. (1) Solenoid Size III, Power 8W
ATEX approval II2 GD Ex d
IIC T6 Gb Ex t IIC T80
Db IP67
-60 °C ≤ Ta ≤ 60 °C
- (2) Solenoid Size II, Power 30W
as per INDIAN approval
Ex d IIC T3 Gb
Ex t IIC T155 Db IP67
-60 °C ≤ Ta ≤ 70 °C



APPROVAL

Approval	certifying Agencies	reference Number
INDIAN	KLPL	
BIS		7229976
CCOE/ PESO		
DGMS		
ATEX	DNV	DNV 12 ATEX 112883X
IECEX	DNV	IECEX, DNV 13.0006X
CU-TR		RU C-IN. ГБ08.B.01100

DIMENSION SOLENOID TYPE : 87

CABLE ENTRY M25X1.5

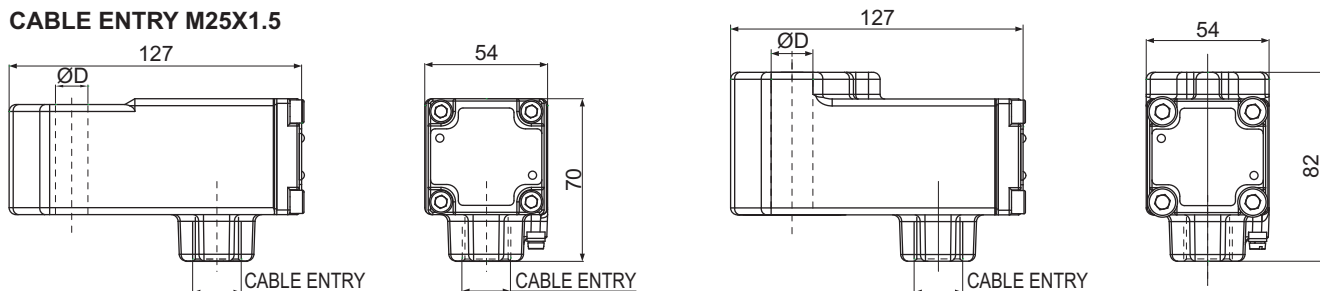

	ØD
III	13
III	14

	ØD
II	18
IV	14

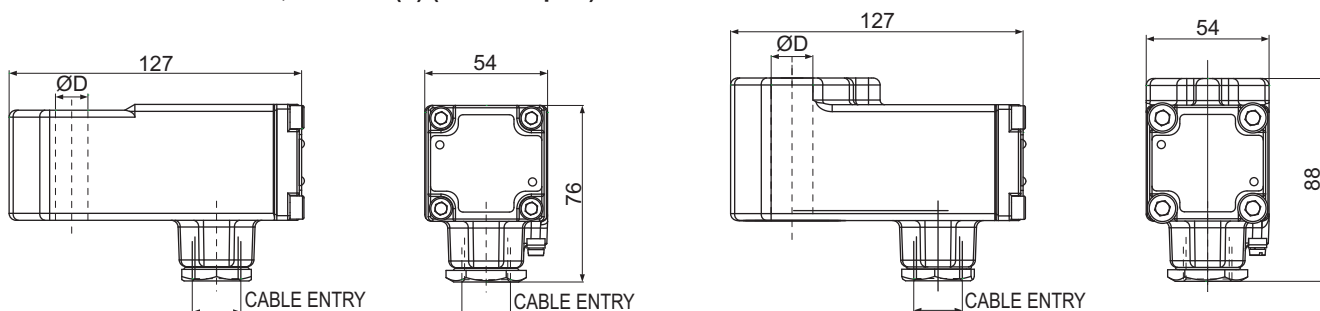

CABLE ENTRY M20X1.5, 1/2" NPT(F) (With Adopter)



	ØD
III	13
III	14

	ØD
II	18
IV	14

OBSELETE PRODUCTS AND ITS INTERCHANGEABILITY

 <p>Replace Solenoid code 87NS or 87MS along with Guide and Plunger assembly</p>	 <p>Replace Solenoid code 87 or 87MS along with Guide and Plunger assembly</p>	 <p>Solenoid code 39 replace with Solenoid code 87MS</p>		
---	---	---	--	--



BARRIER SELECTION**LEGAL CRITERIA**

To meet requirement of installing Valves with Intrinsically safe Solenoid in the hazardous location of zone 0, zone 1, or zone 2, Power to the Intrinsically Safe Solenoid has to be supplied through certified Barrier Zener Diode, Solenoid Driver, Remote I/O (Power Source).

For meeting safety, it is essential to select and match entity parameter of Barrier (Power Source) as well as Field Device (Solenoid Valve) being installed in the hazardous environment. U_o , I_o , P_o , C_o , L_o are the Entity Parameters of the Power Source

U_i , I_i , P_i , C_i , L_i are the Entity Parameters of the Field Device U_i (Voltage), I_i (Current), P_i (Power), of the solenoid (Field Device) should be more than U_o (Voltage), I_o (Current), P_o (Power), of the Power Source. i.e. ($U_i \geq U_o$, $I_i \geq I_o$, $P_i \geq P_o$)

C_i (Capacitance), L_i (Inductance) of the field device and C_c (Capacitance), L_c (Inductance) of the Cable should be less than C_o (Capacitance), L_o (Inductance) of the Power Source
i.e. ($C_i + C_c \leq C_o$ $L_i + L_c \leq L_o$)

FUNCTIONAL CRITERIA**Barrier Data**

Output Volt @ Zero Current (V_{B0}) : _____ Volt
Output Volt @ Maximum Current (V_{BM}) : _____ Volt
Maximum Output Current (I_B) : _____ mA

Solenoid Data

Minimum Operating Volt (V_C) : _____ Volt
Minimum Operating Current (I_C) : _____ mA

Permissible Cable Length (CL)**Resistance Based**

Resistance Based

Maximum Allowable Cable Resistance (R_C) Ohm

$$R_C = [V_{B0} - ((V_{B0} - V_{BM}) * I_C / I_B)] * 1000 / I_C$$

Allowable Maximum Cable Length (CL_R) should have Resistance $\leq R_C$

Capacitance Based

Allowable Capacitance of the Barrier (C_o)

Cable Capacitance (C_c)

Coil Capacitance (C_i) : $C_c = 0$ (for ROTEX IS Solenoid)

$$C_o \geq C_c + C_i$$

Allowable Maximum Cable Length (CL_C) should have Capacitance $\leq C_o$

Inductance Based

Allowable Inductance of the Barrier (L_B)

Cable Inductance (L_c)

Solenoid Inductance (L_s) : $L_s = 0$ (for ROTEX IS Solenoid)

$$L_o \geq L_c + L_i$$

Allowable Maximum Cable Length (CL_L) should have Inductance $\leq L_o$

CL should be minimum of CL_R , CL_C , CL_L

CL should be minimum of CL_R , CL_C , CL_L

CIRCUIT DIAGRAM

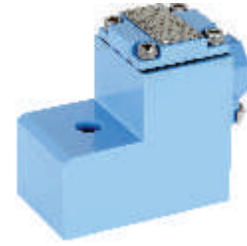
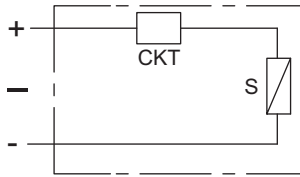

Type : 63, 64



FEATURES

- Designed for extreme environmental conditions
- Large terminals for easy connections
- Bottom Cable entry to avoid rain or process fluids entering into the termination area
- Can be adopted for any valve with core tube 14mm

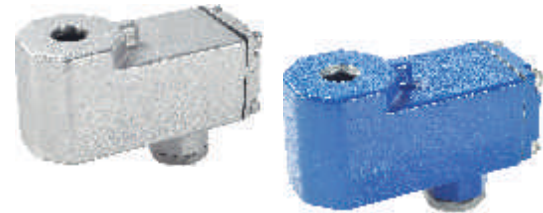

Type : 62, 66

SPECIFICATION

Size	III, IV				
Voltage	24 V				
Current	DC				
Enclosure	<table border="1"> <tr> <td>Cable Entry</td> <td>M25 X 1.5, Adopted to M20 X 1.5 or 1/2" NPT</td> </tr> <tr> <td>Material</td> <td>Aluminum Cast, Polyester Powder Coat, Colour Blue Stainless Steel Cast</td> </tr> </table>	Cable Entry	M25 X 1.5, Adopted to M20 X 1.5 or 1/2" NPT	Material	Aluminum Cast, Polyester Powder Coat, Colour Blue Stainless Steel Cast
Cable Entry	M25 X 1.5, Adopted to M20 X 1.5 or 1/2" NPT				
Material	Aluminum Cast, Polyester Powder Coat, Colour Blue Stainless Steel Cast				
Options	LED (LD)				
Power	Refer entity & minimum operating parameter on page 432A				
Insulation Class	Class H				
Weather Protection	IP67				
Approval	INDIAN, ATEX, CU-TR, IECEx, CCOE, DGMS ①				
Duty Cycle	100% (ED)				
Ambient Temperature	Refer to marking on page 432C				

① DGMS applied for

WEIGHT IN kg

Type	Al	SS
II	0.9	1.6
III	0.8	1.4
IV	0.9	1.6

APPLICATION



INDOOR



OUTDOOR

MINIMUM OPERATING PARAMETER

Operating Parameter	IS Coil with circuit (Size-III) Coil Type : 66	IS Coil with circuit (Size-IV) Coil Type : 62	IS Coil with cut & LED Type : 66 LD	IS Coil with circuit Type : 62 LD
Minimum Voltage	11 Volt	14 Volt	11 Volt	15 Volt
Minimum Current	20mA	25mA	22 mA	27 mA
Minimum Power	0.22 Watt	0.35 Watt	0.24 Watt	0.40 Watt
LED	No	No	Yes	Yes
Valve Type	2XXXX, 3XXXX, 4XXXX 5XXXX, 3XXX, VB (Except 30308, 30334, 30138 & 30318 etc.)	30318LW1.8 & P3017	2XXXX, 3XXXX, 4XXXX 5XXXX, 3XXX, VB (Except 30308, 30334, 30138 & 30318 etc.)	30318LW1.8 & P3017

ENTITY PARAMETER

Entity Parameter	
Ui	32V DC
Ii	230mA
Pi	2.3W
Ci	0
Li	0

RESPONSE ON TIME

Voltage	10	12	14	18	22	26	30	32
Current mA	17	21	25	33	41	49	57	61
Delay Time in Mili Sec.	2500	1200	1000	100	60	50	50	50

RESPONSE OFF TIME

10mS to 20mS

SOLENOID ORDERING CODE

III-24V-DC-66-CO-MS-07

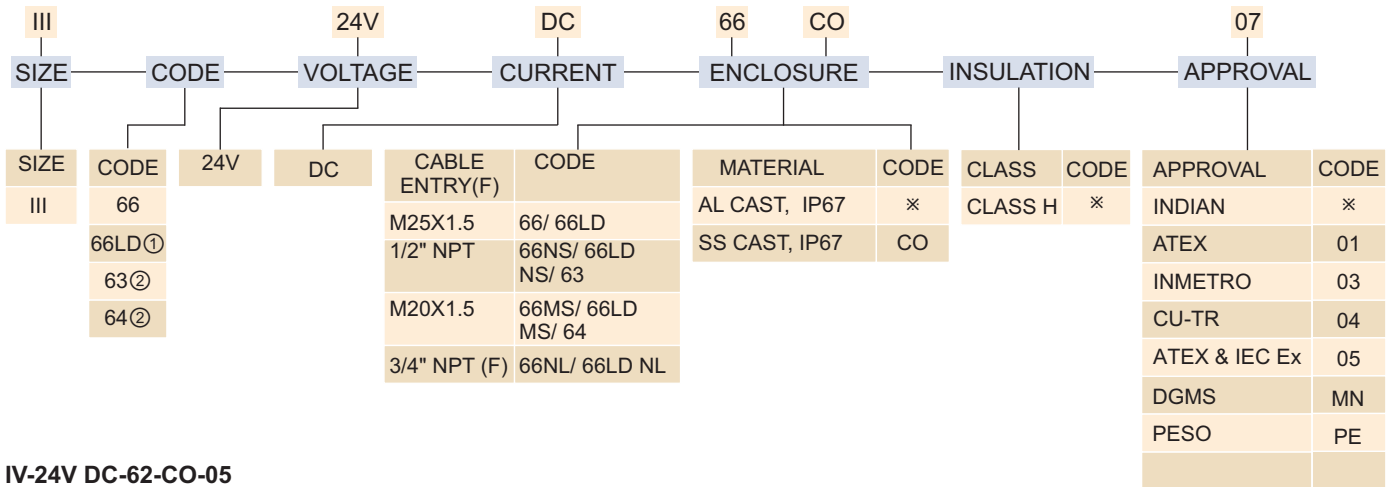

IV-24V DC-62-CO-05

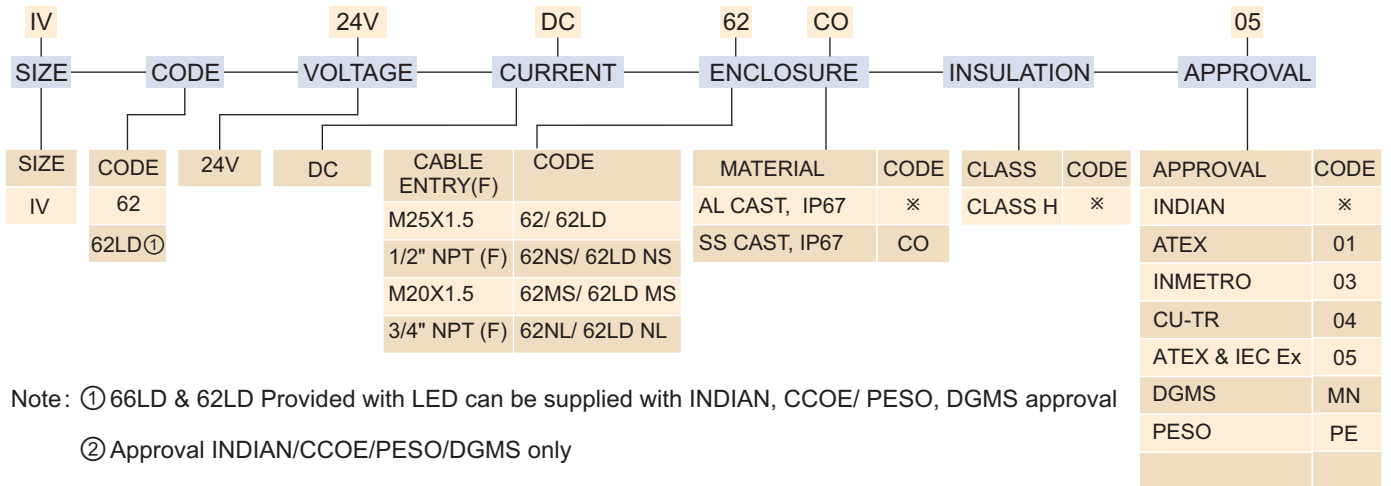

Note: ① 66LD & 62LD Provided with LED can be supplied with INDIAN, CCOE/ PESO, DGMS approval
 ② Approval INDIAN/CCOE/PESO/DGMS only

APPROVAL

Solenoid Type : 62, 66

Approval	Certifying Agencies	Reference Number
INDIAN	KLPL	KLPL/Ex/13-022X
	NA	
DGMS	DGMS	232 of 2011
BIS		7560881
CCOE/ PESO	PESO	
EUROPEAN/ ATEX	Baseefa	Baseefa 12 ATEX 0243X
CU-TR		RU C- IN.Г508.B.01100
INMETRO		
IECEX	Baseefa	IECEX BAS 12.0128XIssu1

MARKING

ATEX & IECEx	AMBIENT TEMPERATURE
⊕ I M I Ex ia II Ma	- 60 °C ≤ Ta ≤ +75 °C
⊕ II 1G Ex ia IIC T5 Ga	- 60 °C ≤ Ta ≤ +75 °C
⊕ II 1G Ex ia IIC T6 Ga	- 60 °C ≤ Ta ≤ +60 °C
⊕ II 1D Ex ia IIIC T200 125 °C IP67Da	- 60 °C ≤ Ta ≤ +75 °C
INDIAN, PESO/ CCOE, DGMS (FOR COIL TYPE 63)	
Ex ia I/IIC T5, IP67	- 40 °C ≤ Ta ≤ +75 °C
Ex ia I/IIC T6, IP67	- 40 °C ≤ Ta ≤ +60 °C
CU-TR	
Ex ia I or	- 60 °C ≤ Ta ≤ 75 °C
Ex ia IIC T5 Ga	- 60 °C ≤ Ta ≤ 75 °C
Ex ia IIC T6 Ga	- 60 °C ≤ Ta ≤ 60 °C
Ex ia IIIC T ₂₀₀ 125 °C Da	

Solenoid Type : 63, 64

Approval	Certifying Agencies	Reference Number
INDIAN	CMRI./ CIMFR	CIMFR/TC/P/H702 & CMRI/TC/SR/H920
	KLPL (Revalidated)	KLPL/Ex/13-022X
BIS		7560881
CCOE/ PESO		
DGMS	DGMS	231 of 2011

* Only for SS cast enclosure



DIMENSION SOLENOID TYPE : 62, 66

CABLE ENTRY M25X1.5

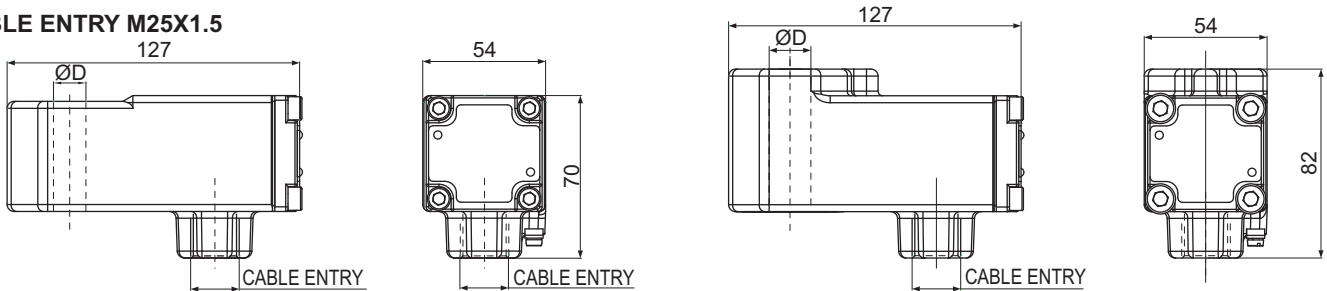

	ØD
III	13
III	14

	ØD
II	18
IV	14

CABLE ENTRY M20X1.5, 1/2" NPT (With Adaptor)

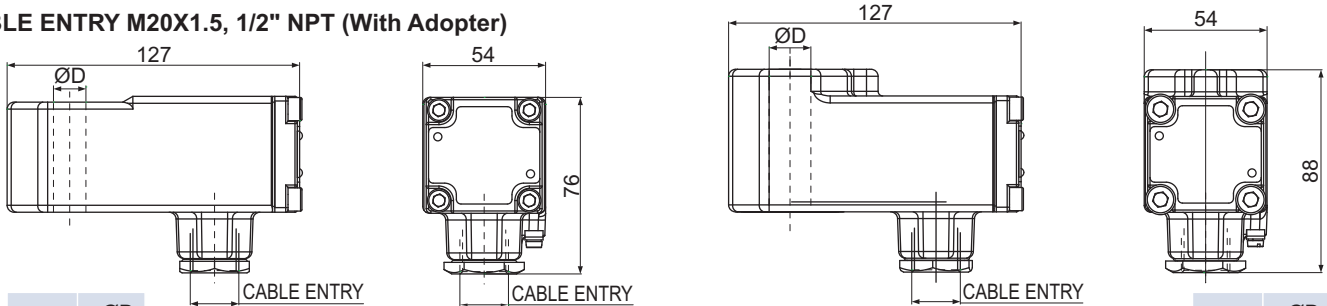

	ØD
III	13
III	14

	ØD
II	18
IV	14

SOLENOID TYPE : 63, 64

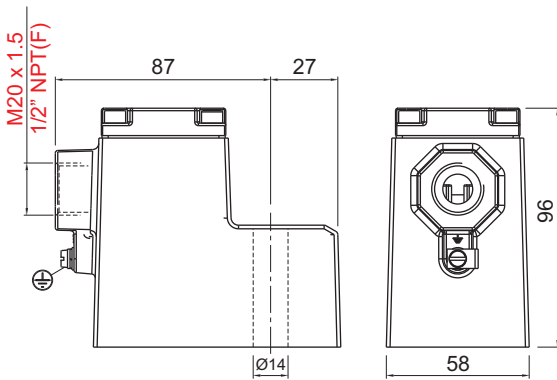

SIZE	B	ØC
III	56	13
I		

OBSELETE PRODUCTS AND ITS INTERCHANGEABILITY

<p>Replace with Solenoid type 66 along with Guide and pressure assembly</p>	<p>Type : 63, 64, 63-01, 64-01</p>  <p>Replace with Solenoid Type 66</p>			
---	---	--	--	--

CIRCUIT DIAGRAM

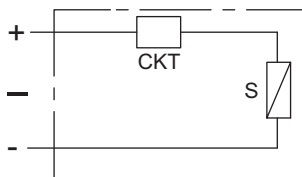

FEATURES

- Designed for extreme environmental conditions
- 'O' Energiser for higher magnetic linkage
- DIN Plug provided



SPECIFICATION

Size	III - 13 mm	
Voltage	24 V	
Current	DC	
Enclosure	Cable Entry	Pg-9, DINPLUG AS PER DIN 43650A
	Material	Steel chrome plated
Insulation Class	Class H	
Weather Protection	IP67	
Approval	INDIAN, CCOE, DGMS①, GOST R	
Duty Cycle	100% (ED)	

① DGMS applied for

ENTITY PARAMETER

Entity Parameter	
Ui	32V DC
Ii	230mA
Pi	2.3W
Ci	0
Li	0

WEIGHT IN kg

Type	Al/ kg	SS
III	0.37	

APPLICATION



SOLENOID ORDERING CODE III-24V-DC-65CR

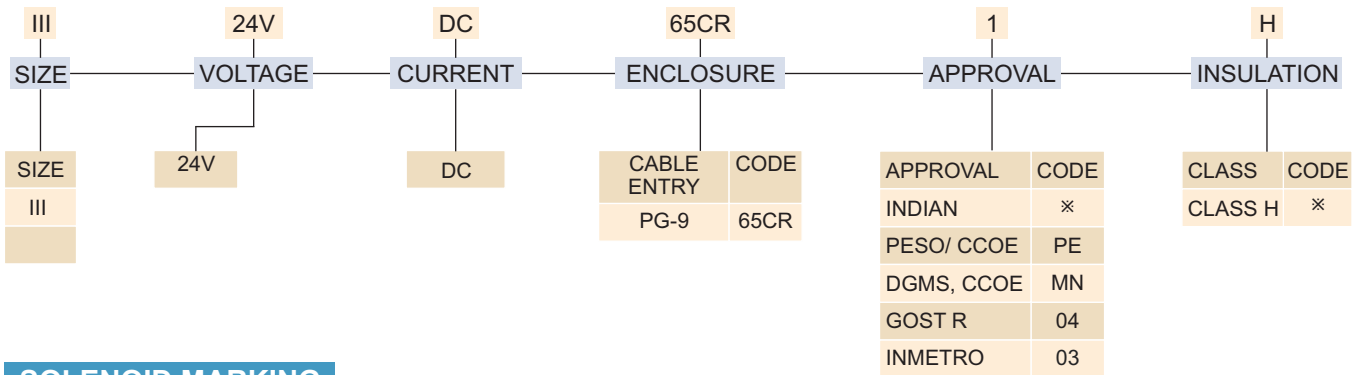

SOLENOID MARKING

Aluminium, Cast	Satinless Steel, Cast
INDIAN	
Ex ia I/ IIC T5, IP67	- 40 °C ≤ Ta ≤ 75 °C
IEx ia I/ IIC T6 IP67	- 40 °C ≤ Ta ≤ 60 °C

MARKING

GOST R	
1Ex (ia) dIIC T6	- 40 °C to +70 °C

MINIMUM OPERATING PARAMETER

Valve Code I3XXX & I5XXX	Max. Pressure 11bar
Minimum Voltage	14V
Minimum Current	25mA
Minimum Power	0.35W
Valve Code I3XXXEP & I5XXXEP	Max. Pressure 14bar
Response ON	50 ms
Response OFF	30 ms

APPROVAL

Approval	Certifying Agencies	Reference Number
INDIAN	KLPL	KLPL/Ex/13-022X
BIS		7560881
CCOE/ PESO*		
DGMS		231 of 2011
GOST R	CIS	POCC IN.Г506.B01292
INMETRO	CEPEL	CEPEL08.1718

DIMENSION

SOLENOID TYPE : 65 CR

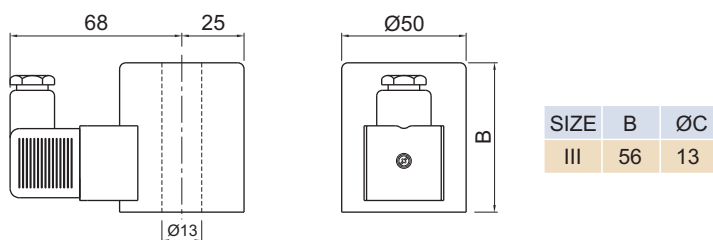

CIRCUIT DIAGRAM

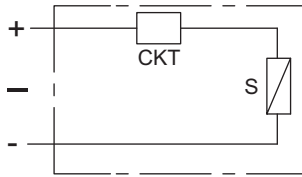

TYPE 71



TYPE 67

FEATURES

- Designed for extreme environmental conditions
- Large terminals for easy connections
- Constructed for lowest temperature rise thus longer life
- 'O' Energiser for higher magnetic linkage
- Wider voltage variation



SPECIFICATION

Size	III - 13 mm, IV - 14 mm
Voltage	24 V
Current	DC
Enclosure	Horizontal Cable Entry Type 67 Bottom Cable Entry Type 71
Cable Entry	M25 X 1.5, Adopted to M20 X 1.5 or 1/2" NPT
Approval	INDIAN, ATEX, CU-TR, CCOE, DGMS ①, IECEx
Ambient Temperature	-60 °C to 70 °C

WEIGHT IN kg

TYPE 67

Size	Al/ kg	SS/ kg
III	0.6	1.4
IV	0.8	1.6

TYPE 71

Size	Al/ kg	SS/ kg
III	0.8	1.4
IV	0.9	1.6

APPLICATION



INDOOR



OUTDOOR



SOLENOID ORDERING CODE III-24V-DC-67

III SIZE		24V VOLTAGE		DC CURRENT		67 ENCLOSURE		1 APPROVAL		H INSULATION	
SIZE	CODE	24V	DC	CABLE ENTRY(F)	CODE	MATERIAL	CODE	APPROVAL	CODE	CLASS	CODE
	67			M25X1.5	67/ 67LD	AL CAST, IP67	※	INDIAN	※	CLASS H	※
III	67			1/2" NPT (F)	67NS/ 67LD NS	SS CAST, IP67	CO	ATEX	01		
	71			M20X1.5	67MS/ 67LD MS			INMETRO	03		
	67LD①							CU-TR	04		
IV	67L							ATEX & IEC Ex	05		
	67LLD①							DGMS, CCOE	MN		
								PESO, CCOE	PE		

IV-24V-DC-71-05

IV SIZE		24V VOLTAGE		DC CURRENT		71 ENCLOSURE		1 APPROVAL		H INSULATION	
SIZE	CODE	24V	DC	CABLE ENTRY(F)	CODE	MATERIAL	CODE	APPROVAL	CODE	CLASS	CODE
III	71			M25X1.5	71/ 71LD	AL CAST, IP67	※	INDIAN	※	CLASS F	※
	71LD①			1/2" NPT (F)	71NS/ 71LD NS	SS CAST, IP67	CO	ATEX	01	CLASS H	H
	71L			M20X1.5	71MS/ 71LD MS			INMETRO	03		
IV	71LLD①			3/4" NPT (F)	71NL/ 71LD NL			CU-TR	04		
								PESO/ CCOE	PE		
								ATEX & IEC Ex	05		

Note : ① 67LD, 71LD, 67LLD, 71LLD Supplied with LED and can be supplied with INDIAN, CCOE/PESO, DGMS approval

APPROVAL Type : 67

Approval	Certifying Agencies	Reference Number
INDIAN	CMRI CIMFR	CMRI/TC/SR/H-834
	KLPL ()Revalidated	KLPL/Ex/13-022X
BIS		7560881
CCOE/ PESO		
DGMS	DGMS	231 of 2011
INMETRO	CEPL	CEPL 08.1718
CU-TR		RU C- IN.ГБ08.B.01100
ATEX	Baseefa	Baseefa12ATEX0243X
IECEX	Baseefa	IECEX BAS 12.0128X

Type : 71

Approval	Certifying Agencies	Reference Number
INDIAN	KLPL Revalidated	KLPL/Ex/13-022X
BIS		7560881
CCOE/ PESO*		
DGMS*		
CU-TR		RU C- IN.ГБ08.B.01100
ATEX	Baseefa	Baseefa12ATEX0243X
IECEX	Baseefa	IECEX BAS 12.0128X



ENTITY PARAMETER

Entity Parameter	
Ui	32V
Ii	230mA
Pi	2.3W
Ci	0
Li	0

MINIMUM OPERATING PARAMETER

Operating Parameter	VALVE TYPE I3XXX & I5XXX, Pressure Maximum 11 kg/ cm2				VALVE TYPE I3XXXEP & I5XXXEP Pressure Maximum 8 kg/ cm2			
	Solenoid Code				Solenoid Code			
	67	67LD	67L	67LLD	67	67LD	67L	67LLD
Minimum Voltage	14V	14V			11V	11V		
Minimum Current	25mA	28mA	CONTACT ROTEX		19mA	22mA	CONTACT ROTEX	
Minimum Power	0.35W	0.39W			0.21W	0.24W		
LED	NO	YES	NO	YES	NO	YES	NO	YES
Response ON	60 ms							
Response OFF	40 ms							

Operating Parameter	VALVE TYPE I3XXX & I5XXX, Pressure Maximum 11 kg/ cm2				VALVE TYPE I3XXXEP & I5XXXEP Pressure Maximum 8 kg/ cm2			
	Solenoid Code				Solenoid Code			
	71	71LD	71L	71LLD	71	71LD	71L	71LLD
Minimum Voltage	14V	14V			11V	11V		
Minimum Current	25mA	28mA	CONTACT ROTEX		19mA	22mA	CONTACT ROTEX	
Minimum Power	0.35W	0.39W			0.21W	0.24W		
LED	NO	YES	NO	YES	NO	YES	NO	YES
Response ON	60 ms							
Response OFF	40 ms							

MARKING Solenoid Type : 67, 67LD

	Ambient Temperature
ATEX & IECEx	
I M1 Ex ia II Ma*	- 60 °C ≤ Ta ≤ 75 °C
II 1G Ex ia IIC T5 Ga	- 60 °C ≤ Ta ≤ 75 °C
II 1G Ex ia IIC T6 Ga	- 60 °C ≤ Ta ≤ 60 °C
II 1D Ex ia IIIC T200 125 °C Da IP67	- 60 °C ≤ Ta ≤ 75 °C
INDIAN, DGMS,CCOE/ PESO	
Ex ia IIC T5 Ga	- 60 °C ≤ Ta ≤ 75 °C
Ex ia IIC T6 Ga	- 60 °C ≤ Ta ≤ 60 °C
CU-TR	
Exia I	- 60 °C to +75 °C
Ex ia IIC T5	- 60 °C to +75 °C
Ex ia IIC T6	- 60 °C to +75 °C
Ex ia IIIC T200 125 °C Da IP67	- 60 °C ≤ Ta ≤ 75 °C

* Only for SS cast enclosure

Solenoid Type : 71, 71LD

	Ambient Temperature
ATEX & IECEx	
I M1 Ex ia II Ma*	- 60 °C ≤ Ta ≤ 75 °C
II 1G Ex ia IIC T5 Ga	- 60 °C ≤ Ta ≤ 75 °C
II 1G Ex ia IIC T6 Ga	- 60 °C ≤ Ta ≤ 60 °C
II 1D Ex ia IIIC T200 125 °C Da IP67	- 60 °C ≤ Ta ≤ 75 °C
INDIAN, DGMS,CCOE/ PESO	
Ex ia IIC T5 Ga	- 60 °C ≤ Ta ≤ 75 °C
Ex ia IIC T6 Ga	- 60 °C ≤ Ta ≤ 60 °C
CU-TR	
Exia I	- 60 °C to +75 °C
Ex ia IIC T5	- 60 °C to +75 °C
Ex ia IIC T6	- 60 °C to +75 °C
Ex ia IIIC T200 125 °C Da IP67	- 60 °C ≤ Ta ≤ 75 °C

* Only for SS cast enclosure



DIMENSION SOLENOID TYPE : 71

CABLE ENTRY M25X1.5

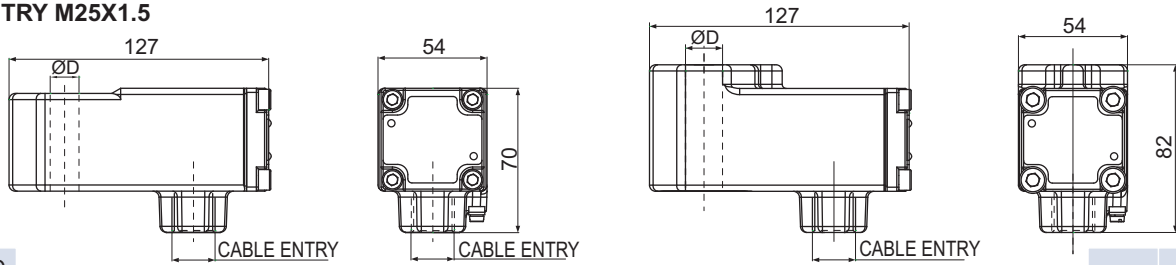

	ØD
III	13
III	14

	ØD
II	18
IV	14

CABLE ENTRY M20X1.5, 1/2" NPT (With Adopter)

SOLENOID TYPE : 71

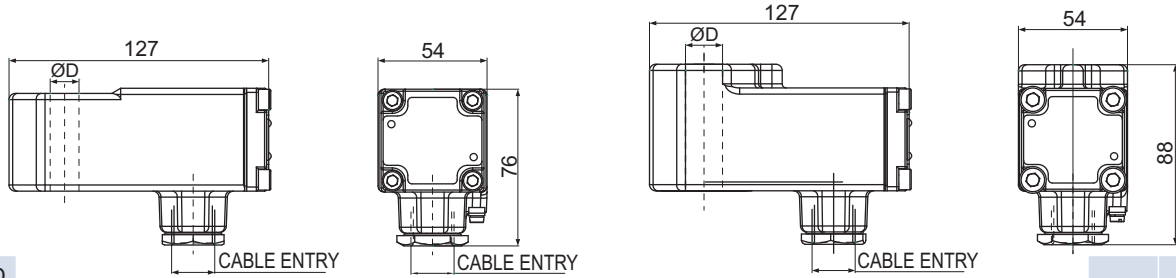

	ØD
III	13
III	14

	ØD
II	18
IV	14

CABLE ENTRY M20X1.5

SOLENOID TYPE : 67

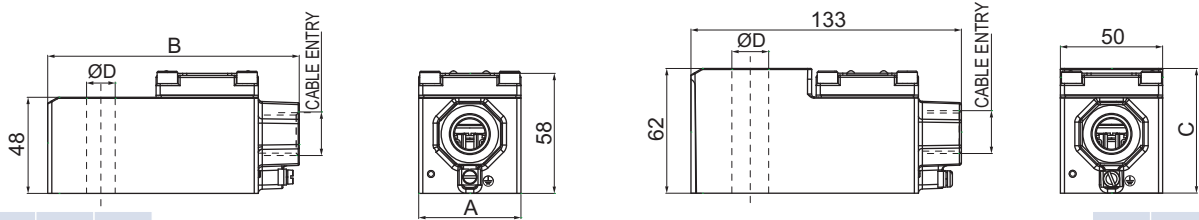

SIZE	A	B	ØD
I	42	116	14
III	50	124	14
III	50	124	13

SIZE	C	ØD
II	61	18
IV	51	14

CABLE ENTRY M20X1.5 & 1/2" NPT (With Adopter)

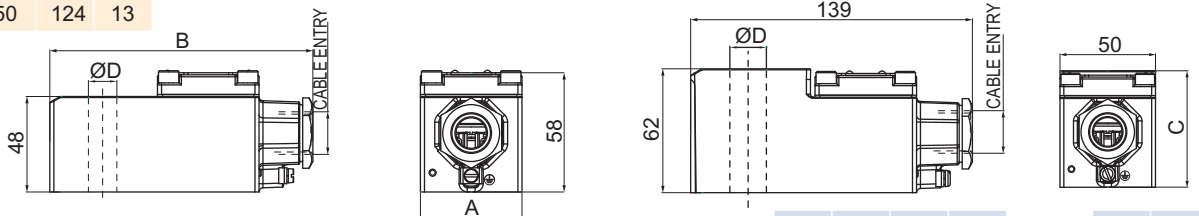

SIZE	A	B	ØE
I	42	122	14
III	50	130	14
III	50	130	13

SIZE	C	ØD
II	61	18
IV	51	14

OBSELETE PRODUCTS AND ITS INTERCHANGEABILITY

	 <p>Coil Type 72 & 73 is been Replaced by 67 & 71</p>		
--	--	--	--